

3. SPOJNI PRIBOR General hardware



3. SPOJNI PRIBOR General hardware

3.1. Škopci

RX-lift

Škopac ravni visokootporni G210 RX-lift

High tensile steel dee shackle G210 RX-lift

2.1 2.2 CE MTCb BL

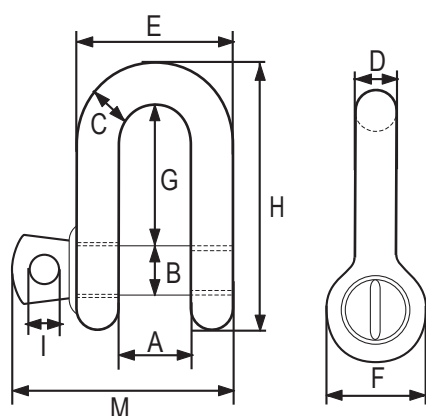

- Standard: EN 13889
- materijal: visokootporni čelik
- Faktor sigurnosti: 6:1
- Završna obrada: vruće galv.

Nosivost (t)	Oznaka	Veličina (in)	A (mm)	B (mm)	C (mm)	D (mm)	E (mm)	F (mm)	G (mm)	H (mm)	I (mm)	M (mm)	Težina (kg/kom)
WLL	Mark	Nom. size											Weight
0,5	1/2	1/4	11.9	7.85	6.35	6.35	24.6	15.5	22.4	40.4	4.85	35.1	0.05
0,75	3/4	5/16	13.5	9.65	7.85	7.85	29.5	19.1	26.2	48.5	5.60	42.2	0.08
1,0	1	3/8	16.8	11.2	9.65	9.65	35.8	23.1	31.8	58.5	6.35	51.5	0.13
1,5	1-1/2	7/16	19.1	12.7	11.2	11.2	41.4	26.9	36.6	67.5	7.85	60.5	0.20
2,0	2	1/2	20.6	16.0	12.7	12.7	46.0	30.2	41.4	77.0	9.65	68.5	0.27
3,25	3-1/4	5/8	26.9	19.1	15.7	16.0	58.5	38.1	51.0	95.5	11.2	85.0	0.57
4,75	4-3/4	3/4	31.8	22.4	20.6	19.1	70.0	46.0	60.5	115	12.7	101	1.20
6,5	6-1/2	7/8	36.6	25.4	24.6	22.4	81.0	53.0	71.5	135	12.7	114	1.43
8,5	8-1/2	1	42.9	28.7	25.4	25.4	93.5	60.5	81.0	151	14.2	129	2.15
9,5	9-1/2	1-1/8	46.0	31.8	31.8	28.7	103	68.5	91.0	172	16.0	142	3.06
12	12	1-1/4	51.5	35.1	35.1	31.8	115	76.0	100	191	17.5	156	4.11
13,5	13-1/2	1-3/8	57.0	38.1	38.1	35.1	127	84.0	111	210	19.1	174	5.28
17,0	17	1-1/2	60.5	41.4	41.1	38.1	137	92.0	122	230	20.6	187	7.23
25,0	25	1-3/4	73.0	51.0	54.0	44.5	162	106	146	279	25.4	231	12.1
35,0	35	2	82.5	57.0	51.0	51.0	184	122	172	312	31.0	263	19.2
55,0	55	2-1/2	105	70.0	66.5	66.5	238	145	203	377	35.1	330	32.5

3. SPOJNI PRIBOR General hardware

3.1. Škopci

Škopac visokootporni omega G209 RX-lift

High tensile steel bow shackle G209 RX-lift

2.1 2.2 CE MTCb BL

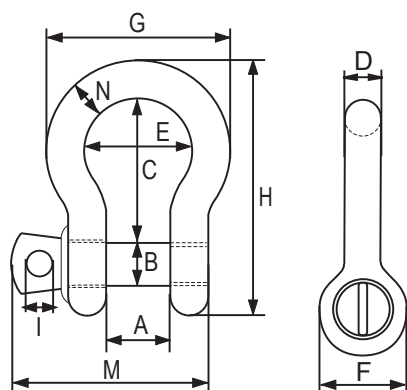

- Standard: EN 13889
- materijal: visokootporni čelik
- Faktor sigurnosti: 6:1
- Završna obrada: vruće galv.

Nosivost (t)	Oznaka	Veličina (in)	A (mm)	B (mm)	C (mm)	D (mm)	E (mm)	F (mm)	G (mm)	H (mm)	I (mm)	M (mm)	N (mm)	Težina (kg/kom)
WLL	Mark	Nom. size												Weight
0,33	1/3	3/16	9.65	6.35	22.4	4.85	15.2	14.2	24.9	37.3	4.06	28.4	4.85	0.03
0,5	1/2	1/4	11.9	7.85	28.7	6.35	19.8	15.5	32.5	46.7	4.85	35.1	6.35	0.05
0,75	3/4	5/16	13.5	9.65	31.0	7.85	21.3	19.1	37.3	53.0	5.60	42.2	7.85	0.09
1,0	1	3/8	16.8	11.2	36.6	9.65	26.2	23.1	45.2	63.0	6.35	51.5	9.65	0.14
1,5	1-1/2	7/16	19.1	12.7	42.9	11.2	29.5	26.9	51.5	74.0	7.85	60.5	11.2	0.17
2,0	2	1/2	20.6	16.0	47.8	12.7	33.3	30.2	58.5	83.5	9.65	68.5	12.7	0.33
3,25	3-1/4	5/8	26.9	19.1	60.5	16.0	42.9	38.1	74.5	106	11.2	85.0	17.5	0.62
4,75	4-3/4	3/4	31.8	22.4	71.5	19.1	51.0	46.0	89.0	126	12.7	101	20.6	1.07
6,5	6-1/2	7/8	36.6	25.4	84.0	22.4	58.0	53.0	102	148	12.7	114	24.6	1.64
8,5	8-1/2	1	42.9	28.7	95.5	25.4	68.5	60.5	119	167	14.2	129	26.9	2.28
9,5	9-1/2	1-1/8	46.0	31.8	108	29.5	74.0	68.5	131	190	16.0	142	31.8	3.36
12,0	12	1-1/4	51.5	35.1	119	32.8	92.5	76.0	146	210	17.5	156	35.1	4.31
13,5	13-1/2	1-3/8	57.0	38.1	133	36.1	92.0	84.0	162	233	19.1	174	38.1	6.14
17,0	17	1-1/2	60.5	41.4	146	39.1	98.5	92.0	175	254	20.6	187	41.1	7.80
25,0	25	1-3/4	73.0	51.0	178	46.7	127	106	225	313	25.4	231	57.0	12.6
35,0	35	2	82.5	57.0	197	53.0	146	122	253	348	31.0	263	61.0	20.4
42,5	42,5	2-1/4	95	65	220	57,0	160	143	274	32	33,0	321	66,0	32s
55,0	55	2-1/2	105	70.0	267	69.0	184	145	327	453	35.1	330	79.5	38.9

3. SPOJNI PRIBOR General hardware

3.1. Škopci

Škopac ravni sa maticom visokootporni G2150 RX-lift

High tensile steel dee shackle with safety pin G2150 RX-lift

2.1 2.2 CE MTCb BL

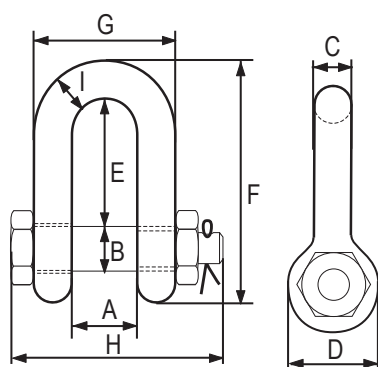

- Standard: EN 13889
- materijal: visokootporni čelik
- Faktor sigurnosti: 6:1
- Završna obrada: vruće galv.

Nosivost (t)	Oznaka	Veličina (in)	A (mm)	B (mm)	C (mm)	D (mm)	E (mm)	F (mm)	G (mm)	H (mm)	I (mm)	Težina (kg/kom)
WLL	Mark	Nom. size										Weight
0,5	1/2	1/4	11.9	7.85	6.35	15.5	19.1	40.4	24.6	39.6	6.35	0.06
0,75	3/4	5/16	13.5	9.65	7.85	19.1	25.4	48.5	29.5	46.2	7.85	0.10
1,0	1	3/8	16.8	11.2	9.65	23.1	31.0	58.5	35.8	55.0	9.65	0.15
1,5	1-1/2	7/16	19.1	12.7	11.2	26.9	36.1	67.5	41.1	63.5	11.2	0.22
2,0	2	1/2	20.6	16.0	12.7	30.2	41.4	77.0	46.0	71.0	12.7	0.34
3,25	3-1/4	5/8	26.9	19.1	16.0	38.1	51.0	95.5	58.5	89.5	16.0	0.67
4,75	4-3/4	3/4	31.8	22.4	19.1	46.0	60.5	115	70.0	103	20.6	1.14
6,5	6-1/2	7/8	36.6	25.4	22.4	53.0	71.5	135	81.0	120	24.6	1.74
8,5	8-1/2	1	42.9	28.7	25.4	60.5	81.0	151	93.5	135	25.4	2.52
9,5	9-1/2	1-1/8	46.0	31.8	28.7	68.5	91.0	172	103	150	31.8	3.45
12,0	12	1-1/4	51.5	35.1	31.8	76.0	100	191	115	165	35.1	4.90
13,5	13-1/2	1-3/8	57.0	38.1	35.1	84.0	111	210	127	183	38.1	6.24
17,0	17	1-1/2	60.5	41.4	38.1	92.0	122	230	137	196	41.1	8.39
25,0	25	1-3/4	73.0	51.0	44.5	106	146	279	162	230	54.0	14.2
35,0	35	2	82.5	57.0	51.0	122	172	312	184	264	51.0	21.2
55,0	55	2-1/2	105	70.0	66.5	145	203	377	238	344	66.5	38.6
85,0	85	3	127	82.5	76.0	165	216	429	279	419	89.0	56

3. SPOJNI PRIBOR General hardware

3.1. Škopci

Škopac visokootporni omega sa maticom G2130 RX-lift

High tensile steel bow shackle with safety pin G2130 RX-lift

2.1 2.2 CE MTCb BL

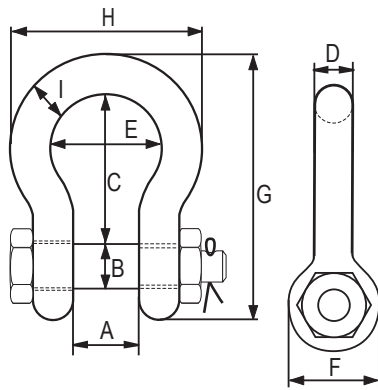

- Standard: EN 13889
- materijal: visokootporni čelik
- Faktor sigurnosti: 6:1
- Završna obrada: vruće galv.

Nosivost (t)	Oznaka	Veličina (in)	A (mm)	B (mm)	C (mm)	D (mm)	E (mm)	F (mm)	G (mm)	H (mm)	I (mm)	Težina (kg/kom)
WLL	Mark	Nom. size										Weight
0,33	1/3	3/16	9.65	6.35	22.4	4.85	15.2	14.2	37.2	24.9	4.85	0.03
0,5	1/2	1/4	11.9	7.85	28.7	6.35	19.8	15.5	46.7	32.5	6.35	0.05
0,75	3/4	5/16	13.5	9.65	31.0	7.85	21.3	19.1	53.0	37.3	7.85	0.10
1,0	1	3/8	16.8	11.2	36.6	9.65	26.2	23.1	63.0	45.2	9.65	0.15
1,5	1-1/2	7/16	19.1	12.7	42.9	11.2	29.5	26.9	74.0	51.5	11.2	0.22
2,0	2	1/2	20.6	16.0	47.8	12.7	33.3	30.2	83.5	58.5	12.7	0.36
3,25	3-1/4	5/8	26.9	19.1	60.5	16.0	42.9	38.1	106	74.5	17.5	0.76
4,75	4-3/4	3/4	31.8	22.4	71.5	19.1	51.0	46.0	126	89.0	20.6	1.23
6,5	6-1/2	7/8	36.6	25.4	84.0	22.4	58.0	53.0	148	102	24.6	1.79
8,5	8-1/2	1	42.9	28.7	95.5	25.4	68.5	60.5	167	119	26.9	2.57
9,5	9-1/2	1-1/8	46.0	31.8	108	28.7	74.0	68.5	190	131	31.8	3.75
12,0	12	1-1/4	51.5	35.1	119	31.8	82.5	76.0	210	146	35.1	5.31
13,5	13-1/2	1-3/8	57.0	38.1	133	35.1	92.0	84.0	233	162	38.1	7.18
17,0	17	1-1/2	60.5	41.4	146	38.1	98.5	92.0	254	175	41.1	9.43
25,0	25	1-3/4	73.0	51.0	178	44.5	127	106	313	225	57.0	15.4
35,0	35	2	82.5	57.0	197	51.0	146	122	348	253	61.0	23.7
42,5	42,5	2-1/4	95	65	220	57	160	143	382	274	67	33,5
55,0	55	2-1/2	105	70,0	267	66,5	184	145	453	327	79,5	44,61
85,0	85	3	127	82.5	330	76.0	200	165	546	365	92.0	70
120,0	120	3-1/2	133	95.5	372	92.0	229	203	626	419	105	120
150,0	150	4	140	108	368	104	254	229	653	468	116	153

3. SPOJNI PRIBOR General hardware

3.1. Škopci

Green Pin škopac visokootporni ravni G-4151

Green Pin® dee shackle with screw collar pin G-4151

2.1 2.2 CE 3.1 MTCa BL

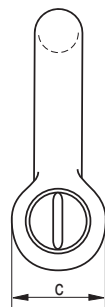
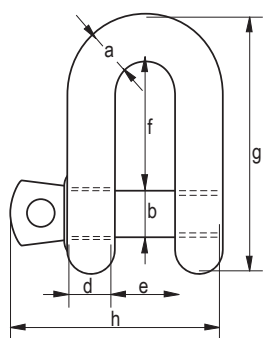

- Standard: EN 13889 te je u skladu sa zahtjevima US Fed. Spec. RR-C-271 Type IVA Class 3, Grade A od 2,0t i naviše škopci su u skladu sa ASME B30.26
- materijal: visokootporni čelik
- Faktor sigurnosti: 6:1
- Završna obrada: vruće galv.

Nosivost (t)	A (mm)	B (mm)	C (mm)	D (mm)	E (mm)	F (mm)	G (mm)	H (mm)	Težina (kg/kom)
WLL									Weight
0,33	5	6	12	5	9,5	19	33	29,5	0,02
0,5	7	8	16,5	7	12	22	41,5	38	0,05
0,75	9	10	20	9	13,5	26	50	46,5	0,09
1	10	11	22,5	10	17	32	59	54	0,14
1,5	11	13	26,5	11	19	37	68	59,5	0,19
2	13,5	16	34	13	22	43	81	73	0,32
3,25	16	19	40	16	27	51	97	89	0,54
4,75	19	22	46	19	31	59	112	103	0,87
6,5	22	25	52	22	36	73	134	119	1,34
8,5	25	28	59	25	43	85	154	137	2,08
9,5	28	32	66	28	47	90	167	153	2,77
12	32	35	72	32	51	94	180	170	3,72
13,5	35	38	80	35	57	115	209	186	5,14
17	38	42	88	38	60	127	230	203	6,85
25	45	50	103	45	74	149	271	243	11,45
35	50	57	111	50	83	171	305	272	16,86
42,5	57	65	130	57	95	190	345	310	24,61
55	65	70	145	65	105	203	376	344	32,65

3. SPOJNI PRIBOR General hardware

3.1. Škopci

Green Pin škopac visokootporni omega G-4161

Green Pin® bow shackle with screw collar pin G-4161

2.1 2.2 CE 3.1 MTCa BL 

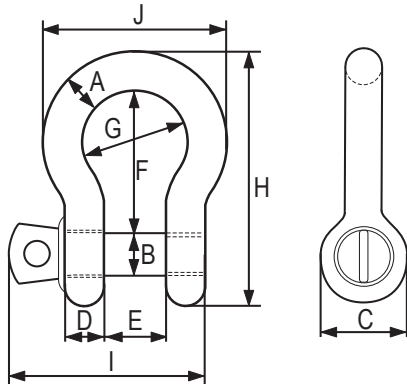

- Standard: EN 13889 te je u skladu sa zahtjevima US Fed. Spec. RR-C-271 Type IVA Class 3, Grade A od 2,0t i naviše škopci su u skladu sa ASME B30.26
- materijal: visokootporni čelik
- Faktor sigurnosti: 6:1
- Završna obrada: vruće galv.

Nosivost (t)	A (mm)	B (mm)	C (mm)	D (mm)	E (mm)	F (mm)	G (mm)	H (mm)	I (mm)	J (mm)	Težina (kg/kom)
WLL											Weight
0,33	5	6	12	5	9,5	22	16	36	29,5	26	0.02
0,5	7	8	16,5	7	12	29	20	48,5	38	34	0.05
0,75	9	10	20	9	13,5	32	22	56	46,5	40	0.10
1	10	11	22,5	10	17	36,5	26	63,5	54	46	0.14
1,5	11	13	26,5	11	19	43	29	74	59,5	51	0.19
2	13,5	16	34	13	22	51	32	89	73	58	0.36
3,25	16	19	40	16	27	64	43	110	89	75	0.63
4,75	19	22	46	19	31	76	51	129	103	89	1,01
6,5	22	25	52	22	36	83	58	144	119	102	1.50
8,5	25	28	59	25	43	95	68	164	137	118	2,21
9,5	28	32	66	28	47	108	75	185	153	131	3,16
12	32	35	72	32	51	115	83	201	170	147	4,31
13,5	35	38	80	35	57	133	92	227	186	162	5,55
17	38	42	88	38	60	146	99	249	203	175	7,43
25	45	50	103	45	74	178	126	300	243	216	12,84
35	50	57	111	50	83	197	138	331	272	238	18,15
42,5	57	65	130	57	95	222	160	377	310	274	26,29
55	65	70	145	65	105	260	180	433	344	310	37,60

3. SPOJNI PRIBOR General hardware

3.1. Škopci

Green Pin škopac visokootporni ravni sa maticom G-4153

Green Pin® dee shackle with safety bolt G-4153

2.1 2.2 CE 3.1 MTCa BL 

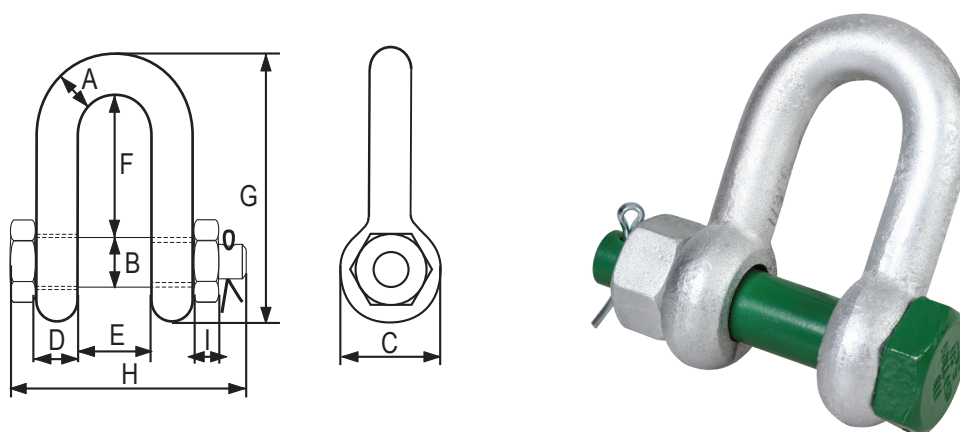

- Standard: EN 13889 te je u skladu sa zahtjevima US Fed. Spec. RR-C-271 Type IVA Class 3, Grade A od 2,0t i više škopci su u skladu sa ASME B30.26
- materijal: visokootporni čelik
- Faktor sigurnosti: 6:1
- Završna obrada: vruće galv.

Nosivost (t)	A (mm)	B (mm)	C (mm)	D (mm)	E (mm)	F (mm)	G (mm)	H (mm)	I (mm)	Težina (kg/kom)
WLL										Weight
2	13,5	16	34	13	22	43	81	82	13	0,39
3,25	16	19	40	16	27	51	97	98	17	0,67
4,75	19	22	46	19	31	59	112	114	19	1,08
6,5	22	25	52	22	36	73	134	130	22	1,66
8,5	25	28	59	25	43	85	154	150	25	2,46
9,5	28	32	66	28	47	90	167	166	27	3,40
12	32	35	72	32	51	94	180	178	30	4,51
13,5	35	38	80	35	57	115	209	197	33	6,10
17	38	42	88	38	60	127	230	202	19	7,63
25	45	50	103	45	74	149	271	249	23	12,88
35	50	57	111	50	83	171	305	269	26	17,35
42,5	57	65	130	57	95	190	345	301	29	25,94
55	65	70	145	65	105	203	376	330	32	35,33
85	75	83	162	73	127	229	427	380	39	52,97

3. SPOJNI PRIBOR General hardware

3.1. Škopci

Green Pin škopac visokootporni omega sa maticom G-4163

Green Pin® bow shackle with safety bolt G-4163

2.1 2.2 CE 3.1 MTCa BL 

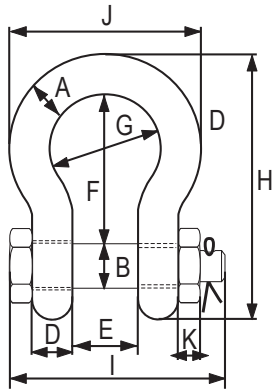

• Standard: EN 13889 te je u skladu sa zahtjevima US Fed. Spec. RR-C-271 Type IVA Class 3, Grade A od 2,0t i naviše škopci su u skladu sa ASME B30.26

- materijal: visokootporni čelik
- Faktor sigurnosti: 6:1
- Završna obrada: vruće galv.



Nosivost (t)	A (mm)	B (mm)	C (mm)	D (mm)	E (mm)	F (mm)	G (mm)	H (mm)	I (mm)	J (mm)	K (mm)	Težina (kg/kom)
WLL												Weight
0,5	7	8	16,5	7	12	29	20	48,5	42	34	4	0.06
0,75	9	10	20	9	13,5	32	22	56	50	40	5	0.11
1	10	11	22,5	10	17	36,5	26	63,5	60	46	8	0,16
1,5	11	13	26,5	11	19	43	29	74	67	51	11	0.22
2	13,5	16	34	13	22	51	32	89	82	58	13	0.42
3,25	16	19	40	16	27	64	43	110	98	75	17	0.74
4,75	19	22	46	19	31	76	51	129	114	89	19	1.18
6,5	22	25	52	22	36	83	58	144	130	102	22	1.77
8,5	25	28	59	25	43	95	68	164	150	118	25	2.58
9,5	28	32	66	28	47	108	75	185	166	131	27	3.66
12	32	35	72	32	51	115	83	201	178	147	30	4.91
13,5	35	38	80	35	57	133	92	227	197	162	33	6.54
17	38	42	88	38	60	146	99	249	202	175	19	8.19
25	45	50	103	45	74	178	126	300	249	216	23	14.22
35	50	57	111	50	83	197	138	331	269	238	26	19.85
42,5	57	65	130	57	95	222	160	377	301	274	29	28.33
55	65	70	145	65	105	260	180	433	330	310	32	39.59
85	75	83	162	73	127	329	190	527	380	340	39	62.00

3. SPOJNI PRIBOR General hardware

3.1. Škopci

Green Pin škopac visokootporni široki omega sa maticom G-4263

Green Pin® wide mouth shackle G-4263

2.1 2.2 CE 3.1 MTCa BL 

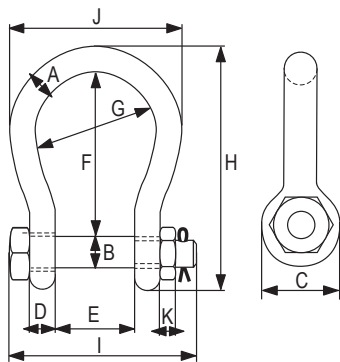

- standard: ASME B30.26
- Faktor sigurnosti: 6:1
- materijal: visokootporni čelik
- Završna obrada: vruće galv.

Nosivost (t)	A (mm)	B (mm)	C (mm)	D (mm)	E (mm)	F (mm)	G (mm)	H (mm)	I (mm)	J (mm)	K (mm)	Težina (kg/kom)
WLL												Weight
4,75	22	25	52	22	63	112	88	173	157	132	23	2.08
6,5	25	28	59	25	75	135	105	204	183	155	25	3.14
8,5	28	32	66	28	82	148	115	225	205	171	27	4.36
9,5	32	35	72	32	90	162	126	248	224	190	30	5.95
12	35	38	79	35	100	180	140	274	245	210	33	7.87
16	38	42	88	38	106	216	159	319	248	235	19	12,50
25	45	50	103	45	127	248	175	370	296	265	23	16.70
30	50	57	118	50	146	273	207	411	332	307	26	25
55	65	70	145	65	165	314	213	487	391	343	32	45
75	83	83	164	83	184	330	254	537	460	420	39	70



3. SPOJNI PRIBOR General hardware

3.1. Škopci

Green Pin "super" škopac visokootporni omega sa maticom G-5263

Green Pin® Super shackles G-5263

2.1 2.2 CE 3.1 MTCa BL 

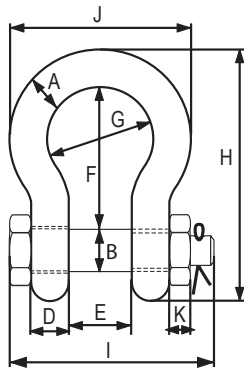

- u skladu sa zahtjevima US Fed. Spec. RR-C-271 Type IVA Class 3, Grade B od 2t i naviše škopci su u skladu sa ASME B30.26
- materijal: visokootporni čelik
- Faktor sigurnosti: 5:1
- Završna obrada: vruće galv.

Nosivost (t)	A (mm)	B (mm)	C (mm)	D (mm)	E (mm)	F (mm)	G (mm)	H (mm)	I (mm)	J (mm)	K (mm)	Težina (kg/kom)
WLL												Weight
3,3	13.5	16	34	13	22	51	32	89	82	58	13	0,44
5	16	19	40	16	27	64	43	110	98	75	17	0,73
7	19	22	46	19	31	76	51	129	114	89	19	1,19
9,5	22	25	52	22	36	83	58	144	130	102	22	1,73
12,5	25	28	59	25	43	95	68	164	150	118	25	2,56
15	28	32	66	28	47	108	75	185	166	131	27	3,6
18	32	35	72	32	51	115	83	201	178	147	30	4,95
21	35	38	80	35	57	133	92	227	197	162	33	6,62
30	38	42	88	38	60	146	99	249	217	175	34	8,11
40	45	50	103	45	74	178	126	300	260	216	40	15
55	57	57	117	57	83	197	138	341	303	252	46	23
85	70	70	143	70	105	260	180	437	363	320	56	44
120	83	83	162	83	127	329	190	535	425	356	66	72
150*	95	95	208	91	147	400	238	647	511	428	50	112
175*	105	108	238	102	169	410	275	688	561	485	60	160



3. SPOJNI PRIBOR General hardware

3.1. Škopci

RX-lift

Škopac DIN 82101 RX-lift

Shackle according to DIN 82101 RX-lift

CE 2.1 2.2

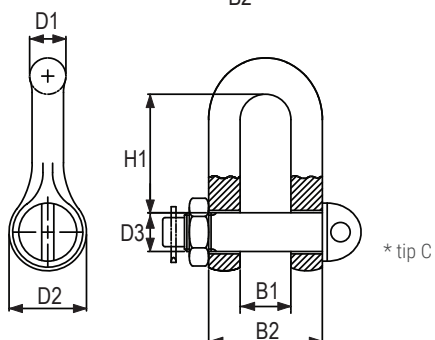
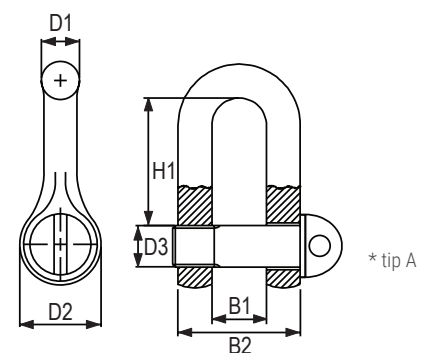

- Faktor sigurnosti: 4:1 ili 5:1
- Završna obrada: vruće galv. ili crni

Nosivost (t)	B1 (mm)	B2 (mm)	D1 (mm)	D2 (mm)	D3 (mm)	H1 (mm)	Težina (kg/kom)
WLL							Weight
0,1	7	15	4	10	M 5	15,5	0,013
0,16	8	18	5	12	M 6	18,0	0,024
0,25	11	25	7	16	M 8	24,0	0,045
0,4	14	30	8	20	M 10	30,0	0,082
0,63	17	37	10	24	M 12	36,0	0,173
1,0	21	47	13	32	M 16	49,0	0,36
1,6	27	61	17	40	M 20	61,0	0,75
2,0	30	68	19	44	M 22	67,0	1,03
2,5	33	75	21	48	M 24	73,0	1,43
3,15	38	86	24	54	M 27	83,5	2,11
4,0	42	96	27	60	M 30	91,0	2,89
5,0	47	107	30	72	M 36	111,0	3,90
6,3	53	121	34	78	M 39	119,5	5,02
8,0	60	136	38	90	M 45	139,5	6,75
10,0	66	150	42	96	M 48	147,0	9,76
12,0	73	167	47	104	M 52	158,0	13,1
16,0	81	185	52	120	M 60	185,0	17,70
20,0	90	206	58	136	M 68	211,0	23,80
25,0	100	226	63	144	M 72	221,0	32,70
32,0	110	250	70	160	M 80	246,0	49,50
40,0	125	283	79	180	M 90	276,0	69,00
56,0	140	316	88	200	M 100	307,0	94,60
63,0	155	347	96	220	M 110	339,0	125,00

3. SPOJNI PRIBOR General hardware

3.1. Škopci

Škopac omega za mooring br. 852

Mooring shackle 852

GUNNEBO 2.1 2.2

MBL (t)	D (mm)	A (mm)	C (mm)	E (mm)	D2 (mm)	D1 (mm)	Težina (kg/kom)
WLL							Weight
28	19	44	100	58	48	21	1,4
40	22	52	125	68	52	25	2,2
60	28	62	150	89	64	28	3,7
90	32	82	170	98	72	32	5,8
110	42	112	200	150	90	45	12,1
150	45	126	248	175	105	50	16,2

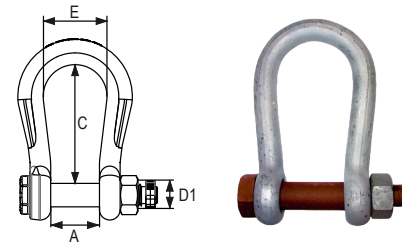

Svornjak škopca za mooring br. 8250

Mooring bolt - eye bolt no. 8250

MBL (t)	Ø X L (mm)	G (mm)	E (mm)
WLL			
40	32x400	72	37
60	38x500	84	44
80	45x600	105	47

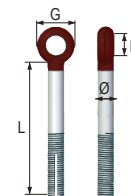

2.1

Svornjak škopca za mooring br. 825

Mooring bolt - t bolt no. 825

MBL (t)	Ø X L (mm)	G (mm)	E (mm)
WLL			
40	32x400	72	35
60	38x500	84	42
80	45x500	105	45
80	45x600	105	45
100	50x500	100	45
100	50x700	110	50

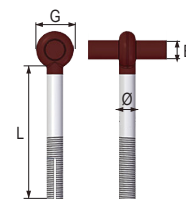

2.1

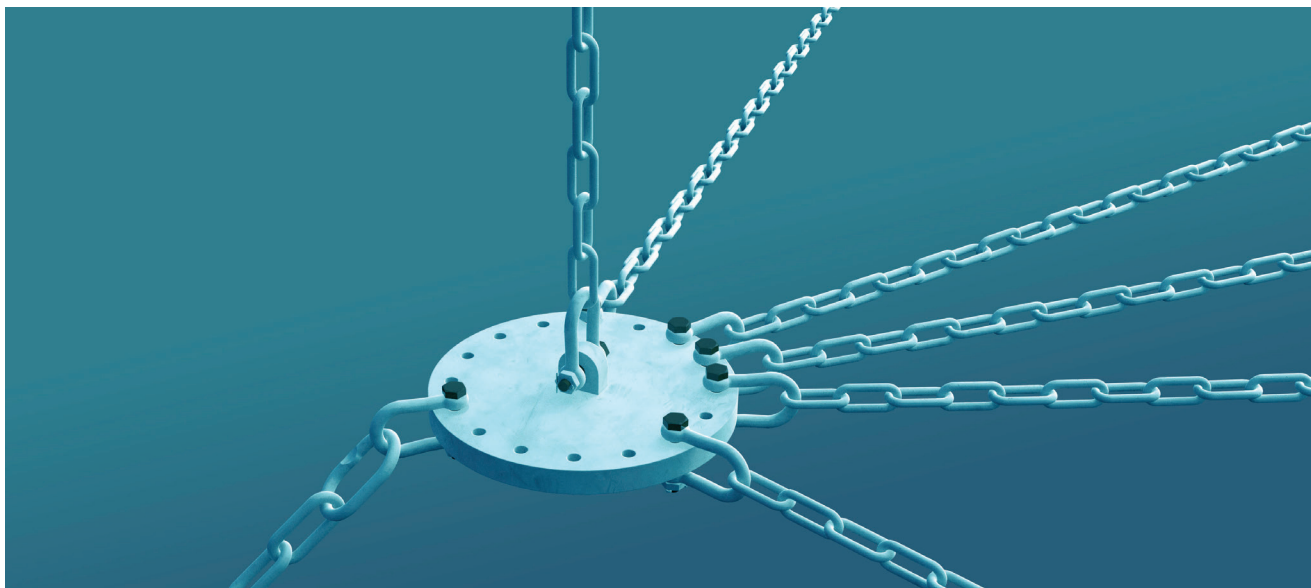

3. SPOJNI PRIBOR General hardware

3.1. Škopci

RX-lift

Škopac komercijalni ravni RX-lift

Commercial type dee shackle RX-lift

2.1

A (mm)	B (mm)	C (mm)	D (mm)	E (mm)	Min. prekidna sila (kN) MBL	Težina (kg/100 kom) Weight (kg/100 pcs)
5	5	10	10	19	1,6	1,4
6	6	12	12	25	2,0	2,2
8	8	16	16	32	4,0	5,2
10	10	20	20	38	6,4	11,8
11	11	22	22	44	8,0	14
12	12	24	24	51	10,4	20,5
14	14	28	28	53	13,0	29,4
16	16	32	32	64	16,0	42,6
20	20	40	40	76	22,0	72,6
22	22	44	44	89	30,0	108
25	25	50	50	100	42,0	185
28	28	56	56	115	60,0	226
32	32	64	64	127	70,0	358
38	38	76	76	152	100,0	602
45	45	90	90	180	140,0	1080

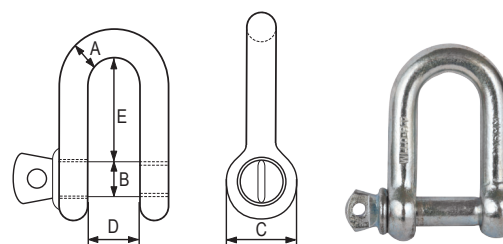

• Škopac za privez, nije za dizanje tereta

Škopac komercijalni trbušasti RX-lift

Commercial type bow shackle RX-lift

2.1

A (mm)	B (mm)	C (mm)	D (mm)	E (mm)	F (mm)	Min. prekidna sila (kN) MBL	Težina (kg/100 kom) Weight (kg/100 pcs)
5	5	10	10	20	15	1,6	1,4
6	6	12	12	24	18	2,0	2,4
8	8	16	16	32	24	4,0	5,4
10	10	20	20	40	30	6,4	10,6
11	11	22	22	44	33	8,0	16,4
12	12	24	24	48	36	10,4	19,4
14	14	28	28	56	42	13,0	44
16	16	32	32	64	48	16,0	44,2
20	20	40	40	80	60	22,0	82,8
22	22	44	44	88	66	30,0	116
25	25	50	50	100	75	42,0	168
28	28	56	56	112	84	60,0	232
32	32	64	64	128	96	70,0	382
38	38	76	76	152	114	100,0	623
45	45	90	90	180	135	140,0	1120

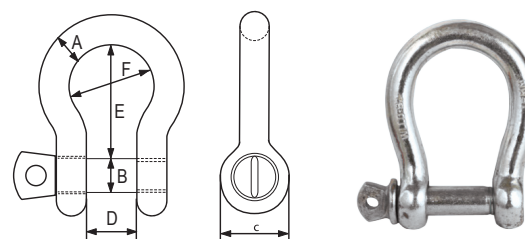

• Škopac za privez, nije za dizanje tereta



3. SPOJNI PRIBOR General hardware

3.2. Karabineri, spojnice

Karabiner DIN 5299 tip C RX-lift

Carabine hook according to DIN 5299 C type RX-lift

Veličina Lx F (mm)	D1 (mm)	D3 (mm)	M (mm)	Težina (kg/100 kom)
Size				Weight (kg/100 pcs)
404	6	4	7	1,1
50X5	8	5	7	1,6
60X6	9	6	8	2,7
70X7	10	7	8	4,4
80X8	10	8	10	6,6
90X9	12	9	10	9,2
100X10	15	10	11	12,8
120X11	18	11	16	18,4
140X12	20	12	19	25,7
160X13	22	13	23	35,3
180X14	22	14	33	49,6

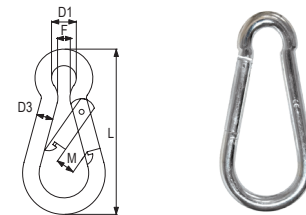

2.1

• za privez, nije za dizanje tereta

Karabiner DIN 5299 tip D RX-lift

Carabine hook according to DIN 5299 D type RX-lift

Veličina Lx F (mm)	D1 (mm)	D3 (mm)	M (mm)	Težina (kg/100 kom)
Size				Weight (kg/100 pcs)
60X6	6	6	8	3,1
70X7	7	7	8	5,0
80X8	9	8	10	7,2
90X9	10	9	10	10,3
100X10	11	10	11	13,8
120X11	15	11	16	20,2

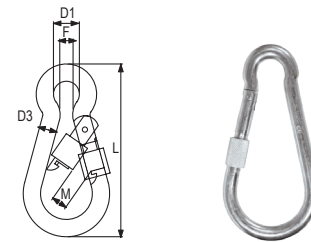

2.1

• za privez, nije za dizanje tereta

Brza spojnica lanca RX-lift

Quick link RX-lift

Veličina (mm)	L1 (mm)	L2 (mm)	F (mm)	Težina (kg/100 kom)
Nom. size				Weight (kg/100 pcs)
3.5	36	17	5	1,2
4	39	19	5,5	1,4
5	48	23	6,5	2,2
6	57	26	7,5	3,6
7	66	30	8,5	5,0
8	76	34	10,5	7,8
9	83	37	11,5	10,0
10	89	40	12,5	13,8
12	107	49	14,5	20,0
14	121	54	17	25,0

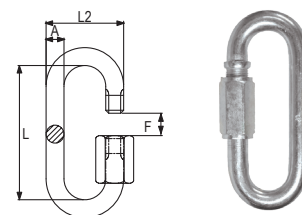

2.1

• za privez, nije za dizanje tereta

Spojnica lanca otvorena RX-lift

Chain connector RX-lift

Veličina (mm)	Ø (mm)	A (mm)	B (mm)
Nom. size			
10	10	50	16
12	12	55	18
16	16	73	22

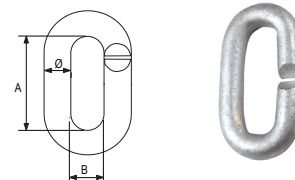

2.1

• za privez, nije za dizanje tereta

3. SPOJNI PRIBOR General hardware

3.2. Karabineri, spojnice

Spojница lanca za krpanje RX-lift

Chain connector RX-lift

Veličina (mm)	B (mm)	H (mm)	M (mm)
Nom. size			
3,5	6,5	17	4
5	9,5	23	6
6	10,5	29	7
8	15	37	9
10	19	41	12

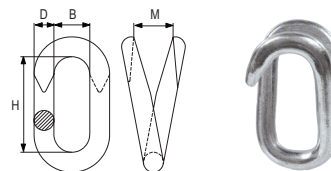

2.1

• za privez, nije za dizanje tereta

Karabiner okretni 5025 tip Z RX-lift

Swivel carabine hook according to DIN 5025 RX-lift

L (mm)	D1 (mm)	Težina (kg/100kom)
		Weight (kg/100pcs)
10	50	2,0
10	75	2,5
12	75	2,7
16	78	3,1
20	82	3,2
32	110	3,8

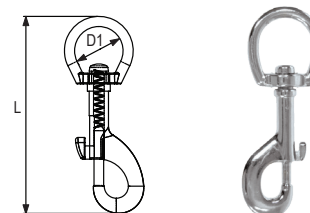

2.1

• za privez, nije za dizanje tereta

Karabiner okretni 5287 tip A RX-lift

Swivel carabine hook according to DIN 5287 A type RX-lift

L (mm)	M (mm)	D1 (mm)	Težina (kg/100 kom)
			Weight (kg/100pcs)
25	3,5	5,5	0,14
30	4,5	6,0	0,17
35	5,0	6,5	0,26
40	5,5	7,0	0,38
45	6,0	8,0	0,55
50	6,5	9,0	0,72
60	7,5	10,0	1,23
70	9,0	11,0	1,90
80	10,0	12,0	2,80

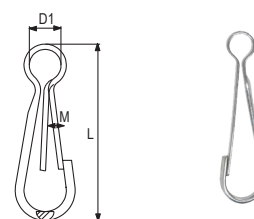

2.1

• za privez, nije za dizanje tereta

Karabiner okretni 5287 tip B RX-lift

Swivel carabine hook according to DIN 5287 B type RX-lift

L (mm)	M (mm)	D1 (mm)	Težina (kg/100 kom)
			Weight (kg/100pcs)
25	3,5	6,5	0,30
30	4,5	7,0	0,38
35	5,0	7,0	0,52
40	5,5	9,0	0,69
45	6,0	9,0	1,00
50	6,5	10,0	1,02
60	7,5	12,0	2,03
70	9,0	15,0	3,30
80	10,0	18,0	4,80

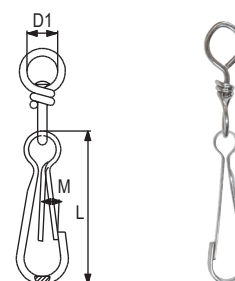

2.1

• za privez, nije za dizanje tereta

3. SPOJNI PRIBOR General hardware

3.2. Karabineri, spojnice

Aluminijska klema DIN 3093 / EN 13411-3 RX-lift

Aluminum ferrules acc. to DIN 3093/ EN 13411-3 RX-lift

2.1

Veličina	A (mm)	B (mm)	S (mm)	L (mm)	Težina (g/kom)
Size					Weight
1	1.2	2.4	0.65	5	0,094
1.5	1.7	3.4	0.75	6	0,211
2	2.2	4.4	0.85	7	0,375
2.5	2.7	5.4	1.05	9	0,499
3	3.3	6.6	1.25	11	0,843
3.5	3.8	7.6	1.5	13	1,32
4	4.4	8.8	1.7	14	1,81
4.5	4.9	9.8	1.9	16	2,61
5	5.5	11.0	2.1	18	3,57
6	6.6	13.2	2.5	21	5,86
6.5	7.2	14.4	2.7	23	7,55
7	7.8	15.6	2.9	25	9,5
8	8.8	17.6	3.3	28	13,7
9	9.9	19.8	3.7	32	19,8
10	10.9	21.8	4.1	35	26,4
11	12.1	24.2	4.5	39	35,8
12	13.2	26.4	4.9	42	45,8
13	14.2	28.4	5.4	46	59,7
14	15.3	30.6	5.8	49	73,5
16	17.5	35.0	6.7	56	111
18	19.6	39.2	7.6	63	156

Veličina	A (mm)	B (mm)	S (mm)	L (mm)	Težina (g/kom)
Size					Weight
20	21.7	43.4	8.4	70	217
22	24.3	48.6	9.2	77	292
24	26.4	52.8	10.0	84	376
26	28.5	57.0	10.9	91	481
28	31.0	62.0	11.7	98	603
30	33.1	66.2	12.5	105	739
32	35.2	70.4	13.4	112	897
34	37.8	75.6	14.2	119	1077
36	39.8	79.6	15.0	126	1275
38	41.9	83.8	15.8	133	1503
40	44.0	88.0	16.6	140	1734
42	46.2	92.4	17.5	147	2024
44	48.4	96.8	18.3	154	2314
46	50.6	101.2	19.2	161	2662
48	52.8	105.6	20	168	3010
50	55.0	110.0	20.8	175	3412
52	57.2	114.4	21.6	182	3813
54	59.4	118.8	22.5	189	4293
56	61.6	123.2	23.3	196	4772
58	63.8	127.6	24.2	203	5326
60	66	132.0	25.0	210	5880

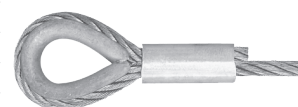
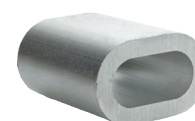
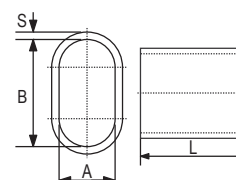

Bakrena klema RX-lift

Copper ferrules RX-lift

2.1

Za užje promjera (mm)	A (mm)	B (mm)	S (mm)	L (mm)
Rope dia.				
1	1.20	2.40	0.65	5
1.5	1.70	3.40	0.75	6
2	2.20	4.40	0.85	7
2.5	2.70	5.40	1.05	9
3	3.30	6.60	1.25	11
3.5	3.80	7.60	1.50	13
4	4.40	8.80	1.70	14
4.5	4.90	9.80	1.90	16
5	5.50	11.00	2.10	18
6	6.60	13.20	2.50	21
6.5	7.20	14.40	2.70	23
7	7.80	15.60	2.90	25
8	8.80	17.60	3.30	28
9	9.90	19.80	3.70	32
10	10.90	21.80	4.10	35
11	12.10	24.20	4.50	39

Za užje promjera (mm)	A (mm)	B (mm)	S (mm)	L (mm)
Rope dia.				
11	12.10	24.20	4.50	39
12	13.20	26.40	4.90	42
13	14.20	28.40	5.40	46
14	15.30	30.60	5.80	49
16	17.50	35.00	6.70	56
18	19.60	39.20	7.60	63
20	21.70	43.40	8.40	70
22	24.30	48.60	9.20	77
24	26.40	52.80	10.00	84

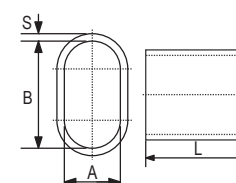

3. SPOJNI PRIBOR General hardware

3.3. Jezgre

Jezgra DIN 6899B RX-lift

Thimble acc. to DIN 6899B RX-lift

Promjer užeta (mm)	A (mm)	C (mm)	B (mm)	D (mm)	E (mm)	Težina (kg/100 kom)	Promjer užeta (mm)	A (mm)	C (mm)	B (mm)	D (mm)	E (mm)	Težina (kg/100 kom)
Wire rope diameter						Weight	Wire rope diameter						Weight
2,5	3	22	19	12	1,6	0,5	24	26	140	99	62	6,8	59
3,5	4	26	21	13	1,6	0,8	26	28	152	112	70	8	80
4	5	32	23	14	1,9	1	28	30	165	120	75	8	110
5	6	38	25	16	2,4	1,6	30	32	178	128	80	8	123
6	7	44	28	18	2,4	1,9	32	34	203	152	95	8,5	156
7	8	51	32	20	2,8	3	34	36	216	160	100	8,5	176
9	10	57	38	24	3,1	4,7	36	38	229	176	110	8,5	192
11	12	64	45	28	3,3	6,8	38	40	241	184	115	10,5	292
13	13	70	48	30	3,3	8	40	42	254	192	120	10,5	320
13	14	76	51	32	3,7	10	42	45	305	240	150	10,5	364
15	16	83	58	36	3,8	14,5	47	50	360	265	160	12	535
16	17	89	61	38	4,7	18	57	60	380	275	170	12	790
17	18	95	64	40	4,7	20	63	65	420	300	180	13	830
18	20	102	72	45	5,7	29	72	75	460	350	200	15	1200
20	22	114	80	50	5,7	32	87	90	500	370	210	18	2600
22	24	127	90	56	6,5	47	97	100	550	380	220	20	3050

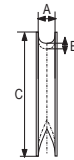
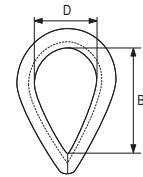

2.1

Jezgra DIN 3090 pojačana RX-lift

Thimble acc. to DIN 3090 RX-lift

Promjer užeta (mm)	A (mm)	B (mm)	C (mm)	D (mm)	E (mm)	F (mm)	Težina (kg/100 kom)	Promjer užeta (mm)	A (mm)	B (mm)	C (mm)	D (mm)	E (mm)	F (mm)	Težina (kg/100 kom)
Wire rope diameter							Weight	Wire rope diameter							Weight
4	5	9	10	20	5,1	2,1	1,4	32	35	55	80	160	38	14	270
6	7	12	15	30	7,1	2,6	3	36	40	60	90	180	42	16	430
8	9	13	20	40	11	4	7,1	40	44	65	100	200	46	18	570
10	11	16	25	50	14	5	17	44	48	70	110	220	53	20	850
12	13	19	30	60	16	6	24	48	53	75	120	240	58	22	1.120
14	16	22	35	70	17	7	31	52	57	80	130	260	64	25	1.530
16	18	25	40	80	19	8	50	56	62	85	140	280	67	25	2.148
18	20	27	45	90	21	9	62	60	66	90	150	300	70	25	2.300
20	22	32	50	100	23	10	90	64	70	95	160	320	78	30	3.500
22	24	33	55	110	24	10	100	68	75	100	170	340	81	30	3.700
24	26	37	60	120	27	11	130	72	79	105	180	360	84	30	4.100
26	29	46	65	130	30	12	220	76	84	115	190	380	87	30	4.600
28	31	50	70	140	33	12	240	80	88	120	200	400	90	30	5.400

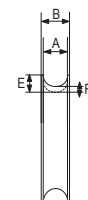
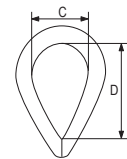

2.1

3. SPOJNI PRIBOR General hardware

3.3. Jezgre

Jezgra DIN 3091 / EN 13411-9 RX-lift

Thimble acc. to DIN 3091 RX-lift

Promjer užeta (mm)	A (mm)	B (mm)	C (mm)	D (mm)	E (mm)	F (mm)	Težina (kg/100 kom)
Wire rope diameter							Weight
8	9	15	40	66	14	–	18
10	11	17,5	50	82	18	–	32
12	13	20	60	98	21	–	52
14	16	23,5	70	114	25	–	80
16	18	26	80	130	28	16	90
18	20	28,5	90	145	31	18	121
20	22	31	100	161	35	20	161
22	24	33,5	110	177	38	22	211
24	26	36	120	193	41	24	271
26	29	39,5	130	209	44	26	355
28	31	42	140	224	47	28	420

Promjer užeta (mm)	A (mm)	B (mm)	C (mm)	D (mm)	E (mm)	F (mm)	Težina (100 kom/kg)
Wire rope diameter							Weight
32	35	47	160	256	53	32	630
36	40	53	180	288	59	36	884
40	44	58	200	320	65	40	1.100
44	48	63	220	352	70	44	1.500
48	53	69	240	384	76	48	2.000
52	57	74	260	416	81	52	2.500
56	62	80	280	448	86	56	3.200
64	70	90	320	512	95	64	4.600
72	79	101	360	576	104	72	6.600
80	88	112	400	640	112	80	9.000

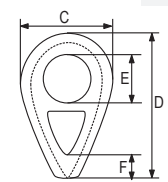

3. SPOJNI PRIBOR General hardware

3.4. Stezaljke

Stezaljka DIN 741 RX-lift

Wire rope clip acc. to DIN 741 RX-lift

2.1 2.2

Promjer čeličnog užeta (mm)	A (mm)	B (mm)	C (mm)	D (mm)	E (mm)	F (mm)	G (mm)	Težina (kg/100 kom)
Wire rope dia.								Weight (100pcs/Kg)
3	4	20	9	12	21	10	10	1,4
5	5	24	11	13	23	11	10	1,5
6	5	28	13	15	26	12	11	1,6
8	6	34	16	19	30	14	15	4,1
10	8	42	19	22	34	18	17	6
11	8	44	20	22	36	19	18	7
13	10	55	24	30	42	23	21	11,8
14	10	57	25	30	44	23	22	12,4
16	12	63	29	33	50	26	26	21
19	12	75	32	38	54	29	30	23,6
22	14	85	37	44	61	33	34	23,8
26	14	95	41	45	65	35	37	41
30	16	110	48	50	74	37	43	62
34	16	120	52	55	80	42	50	75
40	16	140	58	60	88	45	55	104
45	18	163	65	75	97	49	60	134
50	20	170	72	77	106	51	65	175

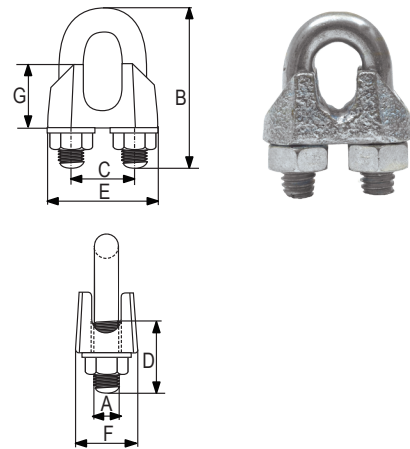

- Standard: DIN 741
- lijevani čelik

Stezaljka pojačana EN 13411-5 tip A (DIN 1142) RX-lift

Wire rope clip acc. to EN 13411-5 tip A (DIN 1142) RX-lift

2.1 2.2

Promjer čeličnog užeta (mm)	A (mm)	B (mm)	C (mm)	D (mm)	E (mm)	F (mm)	G (mm)	Min. broj stezaljki na promjer užeta (kom)	Moment zatezanja (Nm)	Težina (kg/100 kom)
Wire rope dia.								Min. no of clips required)	Torque value	Weight
5	5	25	12	14	25	13	13	3	2,0	2
6,5	6	32	14	17	30	16	14	3	3,5	4
8	8	41	18	20	39	20	18	4	6,0	8,2
10	8	46	20	24	40	20	21	4	9,0	8,4
12	10	56	24	28	50	25	24	4	20	17
14	12	66	28	31	59	30	28	4	33	28,6
16	14	76	34	35	64	32	35	4	49	43
19	14	83	37	36	68	33	40	5	68	49
22	16	96	41	40	74	34	44	5	107	68
26	20	111	46	50	84	38	51	5	147	111
30	20	127	54	55	95	41	59	6	212	140
34	22	141	60	60	105	45	67	6	296	202
40	24	159	68	65	117	49	77	6	363	268

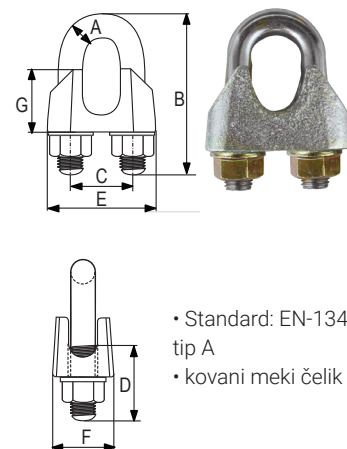

- Standard: EN-13411-5 tip A
- kovani meki čelik

Pravilno postavljanje stezaljki na čelično užu:

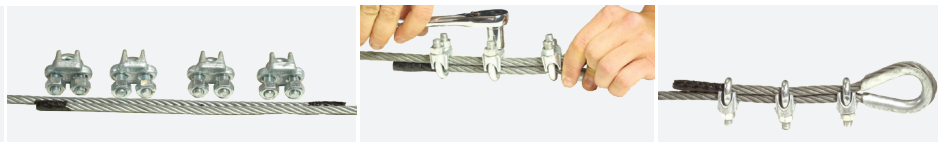

3. SPOJNI PRIBOR General hardware

3.4. Stezaljke

Stezaljka pojačana EN 13411-5 tip B Green Pin

Wire rope clip acc. to EN 13411-5 G-6240 Green Pin



Promjer č. užeta (mm)	A (mm)	B (mm)	C (mm)	D (mm)	E (mm)	F (mm)	G (mm)	Min. br. stezaljki na promjer užeta (kom)	Torzijska vrijednost (Ft. Lbs)	Težina (kg/100 kom)
Dia. wire rope								Min. no of clips required)	Torque value	Weight
3-4	5	24	12	11	24	21	10	2	4,5	2
5	6	31	15	13	29	24	13	2	7,5	4
6-7	8	34	19	13	37	30	18	2	15	8
8	10	45	22	19	43	33	19	3	30	13
9-10	11	49	26	19	49	42	25	3	45	19
11	12	60	30	25	58	46	26	3	65	33
12-13	13	61	30	25	58	48	31	3	65	34
14-15	14	72	33	32	63	52	31	3	95	45
16	14	74	33	32	64	54	36	3	95	45
18-20	16	86	38	37	72	57	38	4	130	68
22	19	98	45	41	80	62	40	4	225	108
24-26	19	108	48	46	88	67	47	5	225	113
28-30	19	117	51	51	91	73	48	6	360	140
32-34	22	130	59	54	105	79	56	7	360	207
36	22	140	60	59	108	79	58	7	360	234
38-40	22	147	66	60	112	85	64	8	430	254
41-42	25	161	70	67	121	92	67	8	590	329
44-46	29	174	78	70	134	97	76	8	750	441
48-52	32	195	86	78	150	113	85	8	750	603
56-58	32	213	98	81	162	116	100	8	750	707
62-65	32	227	105	87	168	119	113	9	750	806
68-72	32	243	112	91	174	127	124	10	750	1015
75-78	38	271	121	98	194	135	136	10	1200	1472

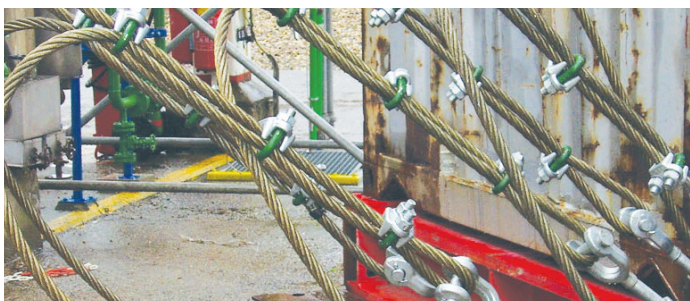
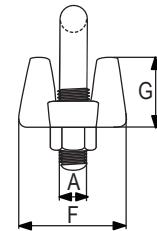
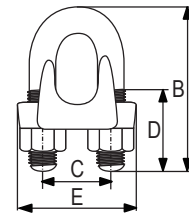

- Standard: EN 13411-5 tip B
- Završna obrada: vruće galv., osim elektro-galv. 5,6,8 i 10 mm
- kovani visokootporni čelik

3. SPOJNI PRIBOR General hardware

3.5. Natezni vijci, zateznice

Natezni vijak DIN 1480 RX-lift

Turnbuckle acc. to DIN 1480 RX-lift

2.1 2.2

Promjer navoja A (mm)	B (mm)	C (mm)	D (mm)	E (mm)	F (mm)	G (mm)	H (mm)	I (mm)	J (mm)	K (mm)	Težina (kg/kom)
5	125	180	70	56	57	35	7	12	16	8	0,07
6	172	258	110	77	80	55	8	15	20	9	0,11
8	184	264	110	85	84	57	10,5	15	22	10	0,2
10	222	311	125	106	105	68	13	11	31	14	0,28
12	241	324	125	117	111	70	16	13	35	16	0,43
14	261	351	140	124	122	75	18	15	40	18	0,61
16	311	427	170	144	150	88	20	17	47	22	1
20	358	490	200	170	167	105	21	21	52	24	1,6
22	414	559	220	200	186	118	24	28	60	27	2,2
24	453	630	255	215	205	135	26	33	65	27	2,8
30	495	660	255	240	220	135	34	35	71	31	4,1
33	545	744	295	260	245	148	38	40	88	36	6
36	597	782	295	275	277	158	46	45	94	38	8,5

- kombinacije završetaka: kuka-kuka, oko-oko, kuka-oko
- materijal: nelegirani čelik
- završna obrada: cinčano ili vruće galv.

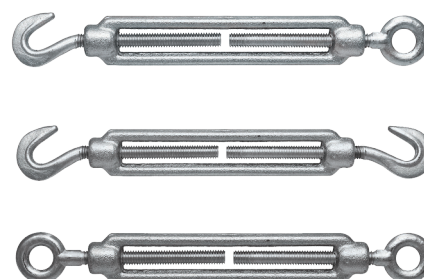
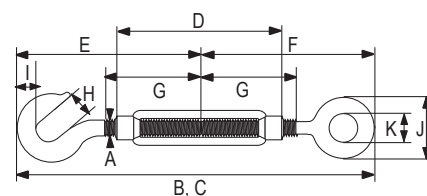

Tijelo nateznog vijka DIN 1480 RX-lift

Turnbuckle frame acc. to DIN 1480 RX-lift

2.1 2.2

D1 (mm)	D2 (mm)	E (mm)	F (mm)	H (mm)	L (mm)	M1 (mm)	M2 (mm)
M 6	12	19	9	6	110	12	6
M 8	15	23	11	8	110	15	8
M 10	18	30	14	9	125	18	9
M 12	21	34	16	11	125	21	11
M 14	25	38	18	10	140	24	9
M 16	27	42	20	14	170	27	14
M 20	34	52	24	17	200	34	17
M 22	36	57	26	16	220	37	15
M 24	39	60	28	20	255	39	20
M 30	45	74	34	23	255	45	23
M 36	55	86	40	28	295	55	28
M 42	63	104	50	32	330	63	32

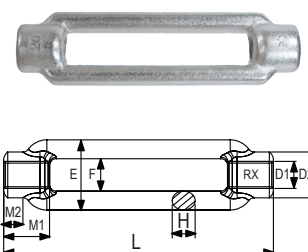

- materijal: nelegirani čelik
- završna obrada: cinčano ili vruće galv.

3. SPOJNI PRIBOR General hardware

3.5. Natezni vijci, zateznice

Natezni vijak DIN 1480 sa ravnim krajevima za varenje RX-lift

Turnbuckle acc. to DIN 1480, stub ends for welding RX-lift

2.1 2.2

Promjer A (mm)	B (mm)	C (mm)	D (mm)	E (mm)	F (mm)	G (mm)	Težina (kg/100 kom)
Dia a							Weight (kg/pc)
6	240	326	110	86	120	65	9,3
8	240	320	110	80	120	65	14
10	300	389	125	89	150	75	29
12	300	383	125	83	150	75	40
14	330	420	140	90	165	85	66
16	400	516	170	116	200	100	89
20	440	572	200	132	220	120	160
22	440	585	220	145	220	130	227
24	520	697	255	177	260	150	282
30	520	685	255	165	260	160	423
36	600	780	295	185	300	180	710

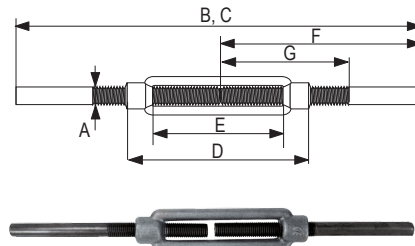

- materijal: nelegirani čelik
- završna obrada: cinčano tijelo cinčano, krajevi crni

Zateznica vilica-vilica DIN 1478 RX-lift

Turnbuckle jaw-jaw acc. to DIN 1478 RX-lift

2.1 2.2

Nosivost (t)	Prekidna sila (kN)	D1 (mm)	D4 (mm)	D5 (mm)	F (mm)	G (mm)	L1 (mm)	L3 (mm)	L4 (mm)	Zategnutost [mm]	Težina (kg/kom)
WLL	BL									Tension	Weight
0,25	10	M8	8	M6X35	25	8	110	101	63	85	26
0,30	12	M10	8	M8X40	29	10	125	122	75	90	45
0,60	24	M12	10	M10X50	35	14	125	151	95	90	66
1,50	70	M16	10	M16	46	20	170	175	105	110	158
3,00	135	M20	12	M20	61	28	200	205	120	130	302
5,50	250	M24	12	M24	71	33	255	255	150	160	509
8,0	360	M30	16	M30	95	44	255	300	175	180	982

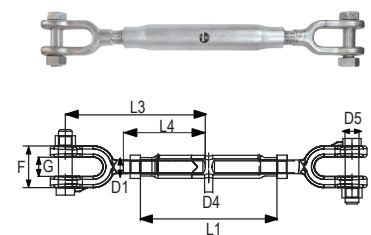

- sa lijevim i desnim navojem
- Završna obrada: vruće cinčano

Natezni vijak komercijalni RX-lift

Commercial type turnbuckle RX-lift

2.1

Veličina D1 (mm)	D2 (mm)	L1 (mm)	L2 (mm)
Size D1			
M5	67	30	8
M6	94	40	10
M8	118	51	11
M10	128	58	12
M12	175	85	16.5
M14	188	90	18
M16	227	92	20
M18	246	95	22
M20	275	110	22
M22	282	120	24
M24	310	148	29
M30	405	170	32
M32	405	172	33
M36	425	215	37

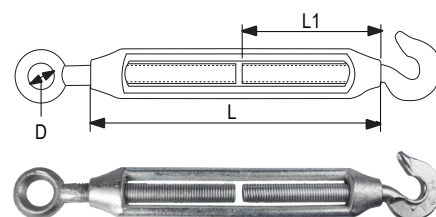

- kombinacije završetaka: kuka-kuka, oko-oko, kuka-oko
- materijal: nelegirani čelik
- završna obrada: cinčano

3. SPOJNI PRIBOR General hardware

3.5. Natezni vijci, zateznice

Zateznica visokootporna cjevasta vilica-vilica RX-lift

Closed body high tensile turnbuckle jaw-jaw RX-lift

2.1 2.2

Nosivost (t)	A (mm)	B (mm)	C (mm)	D (mm)	E (mm)	F (mm)	G (mm)	H (mm)	I (mm)	J (mm)	Težina (kg/kom)
WLL											Weight 1pc/kg
0,2	6	100	170	250	5	16	7	20	13	6	0,15
0,32	8	108	199	279	6	22	9	24	14	8	0,26
0,5	10	125	222	312	8	22	10,5	28	19	8	0,45
0,7	12	195	315	470	10	27	13	34	23	10	0,85
1,2	16	230	388	568	12	33	18	42	29	11	1,51
1,5	20	270	449	654	16	38	20	51	33	12	2,62
2,2	22	295	490	715	20	45	25	55	38	12	3,94
3,2	24	325	538	793	22	52	30	70	46	12	5,16
4,8	33	370	680	965	30	70	38	82	60	14	11,6
6	39	400	707	1002	33	70	45	85	76	15	14,2
8,5	45	400	761	1011	39	86	50	94	85	16	20,8
11	48	400	780	1005	45	97	58	98	92	16	24

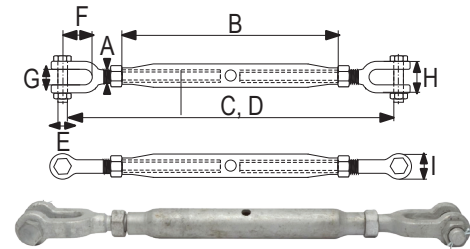

Green Pin zateznica G-6323

Green Pin® Turnbuckle with safety bolt G-6323

2.1 2.2 CE 3.1 MTCa



Nosivost (t)	A (")	Max. duljina produženja vilice (inch)	B (mm)	C (mm)	D (mm)	E (mm)	F (mm)	G (mm)	H (mm)	I (mm)	Težina (kg/kom)
WLL		take up									Weight
0,54	3/8	6	273	409	304	12	21	7	9	21	0,55
1	1/2	6	304	435	343	16	26	10	11	25	0,96
1	1/2	9	379	588	418	16	26	10	11	25	1,18
1	1/2	12	455	740	494	16	26	10	11	25	1,50
1,59	5/8	6	346	469	406	18	32	13	14	33	1,75
1,59	5/8	9	421	622	480	18	32	13	14	33	2,14
1,59	5/8	12	498	774	557	18	32	13	14	33	2,43
2,36	3/4	6	369	487	439	24	38	16	16	41	2,7
2,36	3/4	9	444	640	514	24	38	16	16	41	3,23
2,36	3/4	12	520	792	590	24	38	16	16	41	3,57
2,36	3/4	18	670	1096	740	24	38	16	16	41	4,55
3,27	7/8	12	561	826	638	27	42	19	19	48	5,22
3,27	7/8	18	713	1132	790	27	42	19	19	48	6,56
4,54	1	6	447	554	532	31	50	22	20	54	5,54
4,54	1	12	598	859	683	31	50	22	20	54	6,96
4,54	1	18	750	1168	835	31	50	22	20	54	8,4
4,54	1	24	903	1470	988	31	50	22	20	54	8,9
6,9	1 1/4	12	643	916	748	44	71	28	26	68	11,9
6,9	1 1/4	18	805	1230	910	44	71	28	26	68	13,6
6,9	1 1/4	24	964	1541	1069	44	71	28	26	68	14,2
9,71	1 1/2	12	675	942	806	52	71	35	28	80	18,5
9,71	1 1/2	18	825	1244	956	52	71	35	28	80	19,3
9,71	1 1/2	24	980	1551	1111	52	71	35	28	80	22
12,7	1 3/4	18	938	1316	1092	60	86	41	33	90	30
12,7	1 3/4	24	1089	1621	1243	60	86	41	33	90	33
16,8	2	24	1153	1673	1338	63	93	50	40	107	50
27,2	2 1/2	24	1255	1831	1480	75	114	57	41	143	92
34	2 3/4	24	1348	1882	1604	90	110	70	41	158	109

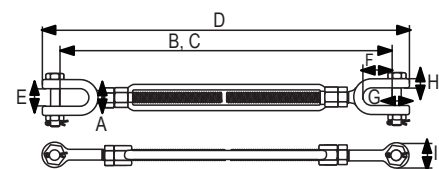

3. SPOJNI PRIBOR General hardware

3.5. Natezni vijci, zateznice

Green Pin zateznica G-6313

Green Pin® Turnbuckle G-6313

2.1 2.2 CE 3.1 MTCa



Nosivost (t)	Promjer oka vilice (mm)	Max. duljina produljenja vilice (inch)	A (mm)	H (mm)	B (mm)	C (mm)	D (mm)	E (mm)	F (mm)	G (mm)	Težina (kg/kom)
WLL	Diameter jaw eye	take up									Weight
2.36	41	6	3/4	16	369	487	439	24	38	16	2.59
2.36	41	9	3/4	16	444	640	514	24	38	16	3.13
2.36	41	12	3/4	16	520	792	590	24	38	16	3.42
2.36	41	18	3/4	16	670	1,096	740	24	38	16	4.51
3.27	48	12	7/8	19	561	826	638	27	42	19	4.93
3.27	48	18	7/8	19	713	1,132	790	27	42	19	6.41
4.5	54	24	1 1/4	20	903	1,470	988	31	50	22	8.9
4.54	54	6	1	20	447	554	532	31	50	22	5.18
4.54	54	12	1	20	598	859	683	31	50	22	6.43
4.54	54	18	1	20	750	1,168	835	31	50	22	8.4
6.9	68	12	1 1/4	26	641	914	748	44	71	29	11.2
6.9	68	18	1 1/4	26	803	1,228	910	44	71	29	13.6
6.9	68	24	1 1/2	26	962	1,539	1,069	44	71	29	15
9.71	80	12	1 1/2	28	675	942	806	52	71	35	17
9.71	80	18	1 1/2	28	825	1,244	956	52	71	35	19.3
9.71	80	24	1 1/2	28	980	1,551	1,111	52	71	35	20.7
12.7	90	18	1 3/4	33	938	1,316	1,092	60	86	41	25
12.7	90	24	1 3/4	33	1,089	1,621	1,243	60	86	41	28.7
16.8	107	24	2	40	1,151	1,671	1,338	63	93	51	45.4
27.2	143	24	2 1/2	41	1,255	1,831	1,480	75	114	57	88
34	158		2 3/4	41	1,348	1,882	1,604	90	110	70	98

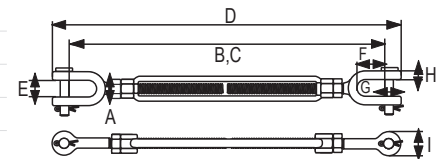

3. SPOJNI PRIBOR General hardware

3.5. Natezni vijci, zateznice

Green Pin zateznica G-6311

Green Pin® Turnbuckle G-6311

2.1 2.2 CE 3.1 MTCa 

Nosivost (t)	A (")	D (mm)	Max. duljina produljenja vilice (inch)	B (mm)	C (mm)	E (mm)	F (mm)	G (mm)	H (mm)	Težina (kg/kom)
WLL			take up							Weight
0.54	3/8	183	6	292	428	10	13	29	49	0.48
1	1/2	193	6	325	455	12	18	36	58	0.81
1	1/2	270	9	400	608	12	18	36	57	1.07
1	1/2	346	12	476	760	12	18	36	57	1.29
1.59	5/8	203	6	380	503	14	21	45	79	1.33
1.59	5/8	280	9	455	656	14	21	45	78	1.61
1.59	5/8	356	12	531	808	14	21	45	78	1.96
2.36	3/4	214	6	413	532	17	26	54	89	2.03
2.36	3/4	291	9	490	685	17	26	54	89	2.47
2.36	3/4	367	12	564	837	17	26	54	88	2.9
2.36	3/4	519	18	718	1,143	17	26	54	89	3.94
3.27	7/8	377	12	604	870	20	32	61	101	4.31
3.27	7/8	529	18	756	1,174	20	32	61	101	5.51
4.5	1	692	24	952	1,518	24	37	76	116	7.52
4.54	1	234	6	498	604	24	37	76	118	4.35
4.54	1	387	12	649	909	24	37	76	117	5.75
4.54	1	539	18	801	1,215	24	37	76	117	7.27
6.9	1 1/4	385	12	712	985	29	47	91	145	9.28
6.9	1 1/4	537	18	862	1,287	29	47	91	144	11.1
6.9	1 1/4	690	24	1,015	1,592	29	47	91	144	12.1
9.71	1 1/2	401	12	756	1,023	32	55	106	156	14.2
9.71	1 1/2	553	18	916	1,335	32	55	106	160	15.8
9.71	1 1/2	706	24	1,065	1,636	32	55	106	158	17.1
12.7	1 3/4	577	18	1,020	1,396	38	61	120	197	23.1
12.7	1 3/4	730	24	1,171	1,703	38	61	120	196	26.3
16.8	2	748	24	1,264	1,784	46	69	147	230	40.7
27.2	2 1/2	802	24	1,430	1,934	51	80	165	274	64
34	2 3/4	802	24	1,450	1,988	57	84	178	284	88

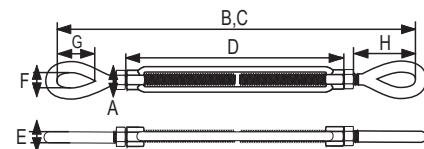

Natezni vijak hamburger RX-lift

Turnbuckle type "hamburger"

Prekidna sila (t)	Promjer navoja A (mm)	B (mm)	C (mm)	D (mm)	Težina (kg/kom)
BL	Dia. thread				Weight (kg/pc)
13	24	400	16	210	2,8
13	24	500	16	260	3,8
18	27	400	18	210	4,4
18	27	500	18	260	5,5
20	30	400	20	210	5
20	30	500	20	260	6,3
21	36	400	20	210	7
21	36	500	20	260	8,8

2.1 2.2

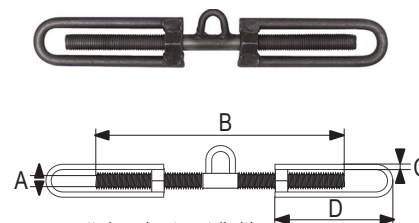

- materijal: nelegirani čelik
- završna obrada: crno

3. SPOJNI PRIBOR General hardware

3.5. Natezni vijci, zateznice

Potezač za žicu ZN RX-lift

Rope tensioning clip RX-lift

Promjer užeta (mm)	Snaga povlačenja (kgs)
Rope dia.	Pulling capacity
1-10	500
1,6-15	1000
4,0-22	2000



2.1

Natezač za žicu sa okruglim okom RX-lift

Rope tensioning clip RX-lift

Veličina (mm)	Promjer užeta (mm)	Presjek užeta (mm)	Nosivost (t)	B (mm)	C (mm)	F (mm)	H (mm)	L (mm)	W (mm)
Nom. size	Rope dia.	Cable cross section	WLL						
4	1-4	1-16	0,5	36	16	19	52	126	19
8	3-8	6-35	1	38	24	22	76	166	21
10	5-10	16-70	1,7	44	26	27	84	202	27

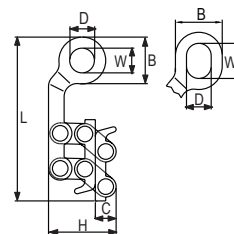

2.1

3. SPOJNI PRIBOR General hardware

3.6. Vrtuljci

Vrtuljak oko-oko RX-lift

Swivel eye-eye RX-lift

Nosivost (t)	A (mm)	B (mm)	C (mm)	D (mm)	E (mm)	F (mm)	G (mm)	Težina (kg/kom)
WLL	Weight							
0.39	6	87	32	18	19	27	75	0,1
0.57	8	106	41	21	25	32	90	0,18
1.02	10	129	51	24	32	38	109	0,3
1.6	13	164	64	33	38	51	138	0,6
2.4	16	199	76	40	44	60	167	1,0
3.3	19	221	89	44	51	67	183	1,82
4.5	22	257	102	52	57	78	213	2,55
5.7	25	295	114	59	64	89	245	4,06
8.2	32	337	143	68	80	94	273	7,43
20.5	38	501	178	102	102	150	425	20,8

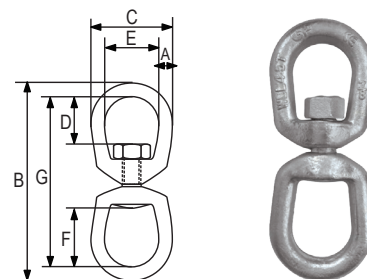

2.1

Vrtuljak vilica-oko RX-lift

Swivel eye-jaw RX-lift

Nosivost (t)	A (mm)	B (mm)	C (mm)	D (mm)	E (mm)	F (mm)	G (mm)	H (mm)	I (mm)	Težina (kg/kom)
WLL	Weight									
0.39	6	84	32	18	19	22	67	12	6	0,09
0.57	8	98	41	21	25	22	75	13	8	0,16
1.02	10	121	51	24	32	27	92	16	10	0,32
1.6	13	154	64	33	38	33	114	19	13	0,57
2.4	16	186	76	40	44	38	135	24	16	1,12
3.3	19	211	89	44	51	44	154	29	19	1,76
4.5	22	242	102	52	57	52	178	30	22	2,66
5.7	25	290	114	59	64	71	217	44	29	4,02
8.2	32	329	143	68	80	71	230	52	35	7,14
20.5	38	501	178	106	102	113	364	73	50	24,8

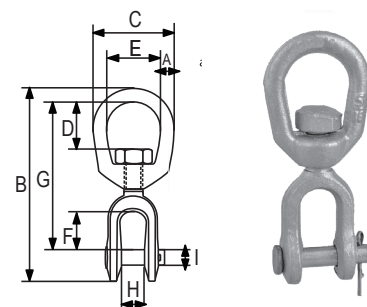

2.1

3. SPOJNI PRIBOR General hardware

3.7. Očni vijak i matica

Očni vijak DIN 580 RX-lift

Eye bolt acc. to DIN 580 RX-lift

CE 2.1 2.2

Nosivost (t)	D1 (mm)	D2 (mm)	D3 (mm)	D4 (mm)	H (mm)	K (mm)	L (mm)	Težina (kg/100 kom)
WLL								Weight
0,08	M 6	20	36	20	36	8	13,0	5
0,14	M 8	20	36	20	36	8	13,0	6
0,23	M 10	25	45	25	45	10	17,0	11
0,34	M 12	30	54	30	53	12	20,5	18
0,49	M 14	35	63	35	62	14	27,0	28
0,70	M 16	35	63	35	62	14	27,0	28
0,85	M 18	40	72	40	71	16	30,0	45
1,20	M 20	40	72	40	71	16	30,0	45
1,40	M 22	50	90	50	90	20	36,0	87
1,80	M 24	50	90	50	90	20	36,0	87
2,10	M 27	55	96	50	97	20	39,0	88
3,20	M 30	65	108	60	109	24	45,0	166
3,20	M 33	65	108	60	109	24	45,0	166
4,60	M 36	75	126	70	128	28	54,0	265
4,60	M 39	85	144	80	147	32	63,0	403
6,30	M 42	85	144	80	147	32	63,0	403
6,30	M 45	100	166	90	168	38	68,0	638
8,60	M 48	100	166	90	168	38	68,0	638
8,60	M 52	110	184	100	187	42	78,0	880
11,50	M 56	110	184	100	187	42	78,0	880
16,0	M 64	120	206	110	208	48	90,0	1240
20,0	M 72	150	260	140	260	60	100,0	2330
28,0	M 80	170	296	160	298	68	112,0	3420
40,0	M 100	190	330	180	330	75	130,0	3640

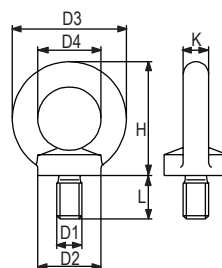

- završna obrada: cinčani, crni ili polirani
- materijal C15



Očna matica DIN 582 RX-lift

Eye nut acc. to DIN 582 RX-lift

CE 2.1 2.2

Nosivost (t)	D1 (mm)	D2 (mm)	D3 (mm)	D4 (mm)	H (mm)	K (mm)	Težina (kg/100 kom)
WLL							Weight
0,08	6	20	36	20	36	8	4,8
0,14	8	20	36	20	36	8	5,0
0,23	10	25	45	25	45	10	9,0
0,34	12	30	54	30	53	12	16,0
0,49	14	35	63	35	62	14	24,0
0,70	16	35	63	35	62	14	24,0
0,85	18	40	72	40	71	16	36,0
1,20	20	40	72	40	71	16	36,0
1,40	22	50	90	50	90	20	72,0
1,80	24	50	90	50	90	20	72,0
2,10	27	55	96	53	97	22	70,0
3,20	30	65	108	60	109	24	132,0
3,20	33	65	108	60	109	24	130,0
4,60	36	75	126	70	128	28	208,0
4,60	39	85	144	80	147	32	202,0
6,30	42	85	144	80	147	32	311,0
6,30	45	100	166	90	168	38	304,0

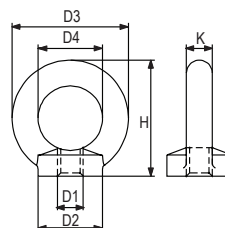

Nosivost (t)	D1 (mm)	D2 (mm)	D3 (mm)	D4 (mm)	H (mm)	K (mm)	Težina (kg/100 kom)
WLL							Weight
6,30	45	100	166	90	168	38	304,0
8,60	48	100	166	90	168	38	502,0
8,60	52	110	184	100	187	42	495,0
11,50	56	110	184	100	187	42	669,0
16,00	64	120	206	110	208	48	930,0
20,0	72	150	260	140	260	60	1850,0
28,0	80	170	296	160	298	68	2730,0
40,0	100	190	330	180	330	75	3640,0

- završna obrada: cinčani, crni ili polirani
- materijal C15

3. SPOJNI PRIBOR General hardware

3.8. Osigurači, kuke, koloturnici

Preklopni osigurač RX-lift

Linch pin RX-lift

A (mm)	B (mm)	C (mm)	D (mm)	Težina (kg/100 kom) Weight
4,5	3,4	34	42	2,0
6	3,4	41	42	2,8
7	3,4	41	42	3,0
8	3,4	41	42	3,5
9	3,4	41	42	3,8
10	3,4	41	42	4,4
11	3,4	41	42 </td <td>4,6</td>	4,6

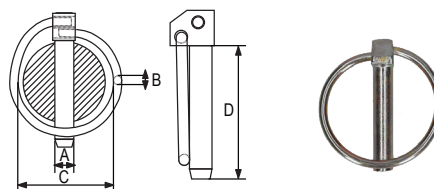

2.1

• završna obrada: cinčano

Osigurač preklopni DIN 11023 RX-lift

Linch pin acc. to DIN 11023 RX-lift

Veličina (mm) Size	B1 (mm)	B2 (mm)	B3 (mm)	D1 (mm)	D3 (mm)	D5 (mm)	H (mm)	L1 (mm)	Težina (kg/100) Weight
5x32	11,5	7	36	4,5	25	2,5	18	32	2,3
6x42	14,0	8	52	5,5	32	3,6	22	42	3,2
8x42	15,0	9	52	7,5	32	3,6	22	42	3,7
10x45	15,0	12	52	9,5	32	3,6	22	45	5,3
12x45	15,0	14	52	11,0	32	3,6	22	45	5,9
12x55	15,0	14	60	11,0	45	4,0	22	55	7,2
17x60	21,0	20	60	16,0	45	4,0	29	60	18,0

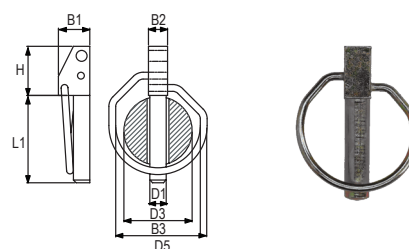

2.1

• završna obrada: cinčano

Osigurač preklopni za cijevi RX-lift

Linch pin for tubes RX-lift

Veličina D (mm) Size	C (mm)	F (mm)	L (mm)	Težina (kg/100) Weight
6	22	3	45	2,9
8	18	3	40	3,0
8	22	3	45	3,2
8	25	3	50	4,8

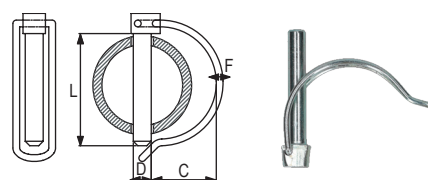

2.1

• završna obrada: cinčano

S kuka RX-lift

S hook RX-lift

Veličina D (mm)	A (mm)	C (mm)	Težina (kg/100 kom) Weight
3	25	3	0,37
4	35	4,5	0,8
5	45	6,5	1,55
6	55	7	2,6
7	65	8	4,34
8	75	10	6,6
10	105	11	15,05
12	120	13,5	21,2

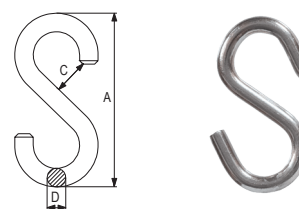

2.1

• završna obrada: cinčano

3. SPOJNI PRIBOR General hardware

3.8. Osigurači, kuke, koloturnici

O karika RX-lift

O ring RX-lift

Veličina (mm) Nom. size	D1 (mm)	D2 (mm)	Težina (kg/100 kom) Weight
5x30	5	30	1,75
6x40	6	40	3,70
7x35	7	35	4,0
8x40	8	40	6,30
9x40	9	40	8,10
9x45	9	45	8,10
9x50	9	50	9,60
10x40	10	40	10,20
10x50	10	50	12,00

2.1

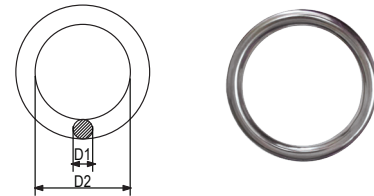

• završna obrada: cinčano

Beta osigurač RX-lift

Spring pin clip-single wined RX-lift

D1 (mm) Size D1	D2 (mm)	L1 (mm)	L2 (mm)	D3 (mm)	D4 (mm)	Težina (kg/100 kom) Weight
2	10	50	25	2.5	9-14	0,33
3	18	60	28	3.5	10-16	1,35
4	20	60	30	4.5	16-20	2,84
5	24	85	40	6.0	20-28	5,30
6	30	105	50	7.0	28-40	10
7	30	105	50	8.0	28-45	12
8	28	110	55	9.0	30-45	17,10

2.1

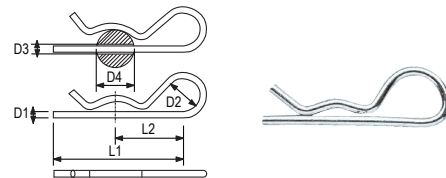

• završna obrada: cinčano

Beta osigurač dupli RX-lift

Spring pin clip-double wined RX-lift

D1 (mm) Size D1	D2 (mm)	L1 (mm)	L2 (mm)	D3 (mm)	D4 (mm)	Težina (kg/100 kom) Weight
2	10	50	25	2.5	8-14	0,23
3	16	62	32	3.5	14-20	0,91
4	23	78	44	4.5	17-24	1,67
5	26	92	50	5.5	18-30	3,38
6	30	120	70	6.5	24-36	6,15
7	30	130	72	8	26-40	8,54
8	30	130	76	9	24-40	12,20

2.1

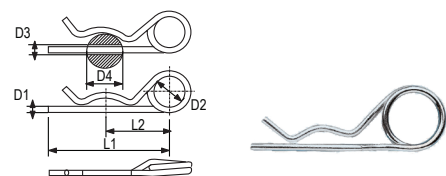

• završna obrada: cinčano

Napinjač RX-lift

Tension clip RX-lift

Dužina (mm) Lenght	Težina (kg/100 kom) Weight
100	0,082

2.1



• završna obrada: cinčano ili lakirano

3. SPOJNI PRIBOR General hardware

3.8. Osigurači, koloturnici

Koloturnik PVC jednostruki RX-lift

Tackle, single RX-lift

Promjer užeta M (mm)	WLL (t)	D1 (mm)	D2 (mm)	L (mm)	Težina (kg/100 kom)
Rope dia.					Weight
5	0,15	10	15	50	2,4
6	0,2	11	20	60	4,1
7	0,23	12	25	70	5,6
8	0,25	13	30	80	8,3
10	0,3	14	40	93	12,7
12	0,39	16	50	113	19,4

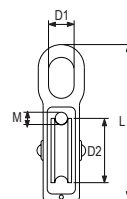

2.1

- završna obrada: cinčano
- materijal užnice: PVC

Koloturnik PVC dvostruki RX-lift

Tackles, double RX-lift

Promjer užeta M (mm)	WLL (t)	D1 (mm)	D2 (mm)	L (mm)	Težina (kg/100 kom)
Rope dia.					Weight
5	0,15	10	15	50	3.7
6	0,20	11	20	60	6.1
7	0,23	12	25	70	8.9
8	0,25	13	30	80	13.2
10	0,30	14	40	93	27.2
12	0,39	16	50	113	41.2

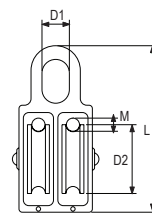

2.1

- završna obrada: cinčano
- materijal užnice: PVC

3. SPOJNI PRIBOR General hardware

3.9. Zatvarači

Zatvarač užni DIN 15315 RX-lift

Wedge socket acc. to DIN 15315 RX-lift

Veličina (mm)	Užad promjera (mm)	H1 (mm)	W (mm)	B (mm)	D (mm)	E (mm)	H2 (mm)
Size	Rope dia.						
5	4-5	68	19	12	10	14	110
6,5	5-6,5	58	19	15	10	16	100
8	6-8	92	25	14	12	20	150
11	9-11	117	32	17	16	26	190
14	12-14	141	38	22	18	32	230
17	15-17	162	46	25	22	36	260
20	18-20	186	52	27	25	40	300
25	22-25	180	60	40	42	40	285
30	26-30	182	62	55	52	55	335

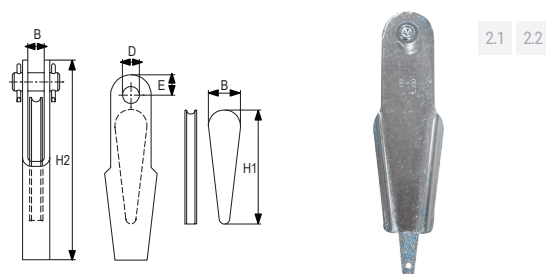

- DIN 15315
- sa maticom i osiguračem
- nelegirani čelik

Zatvarač užni otvoreni OWS TIP

Open wedge socket OWS type

Min. prekidna sila (Mt)	Za užu promjera (mm)	A (mm)	D (mm)	E (mm)	F (mm)	G (mm)	H (mm)	Ø P (mm)	X (mm)	Težina (kg/kom)
MBL	For rope dia.									Weight
8	7-8	130	20	34	9	18	110	17,5	40	0,7
12	9-10	150	23	40	11	20,5	125	20,6	45	1,2
20	11-13	183	27	48	12,7	25,5	156	25,4	60	2,3
25	14-16	224	32	56	14,5	32	192	30	65	3,6
40	17-19	272	40	68	16,5	38	232	35	70	6,3
55	20-22	312	48	80	20,5	45	264	41	80	10,3
80	23-26	370	58	100	22,5	51	312	51	90	16
100	27-29	413	65	110	25	57	348	57	100	21,5
120	30-32	455	72	124	28	63	384	63	110	30
130	34-36	508	76	132	28	70	432	63	125	36
160	37-39	548	80	140	30	76	468	70	140	50
200	40-42	589	85	150	33	76	504	76	155	60
250	43-48	674	98	170	39	89	576	89	175	90
300	49-52	733	108	186	46	101	625	95	195	125
375	54-58	816	120	210	53	113	696	108	220	175
450	60-68	950	133	230	60	127	817	121	250	250
600	72-76	1057	145	250	76	146	912	133	280	400
650	81-86	1160	160	275	79	159	1000	140	330	515

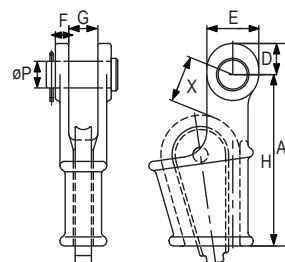

- EN 13411-6
- završna obrada: vruće galv.

3. SPOJNI PRIBOR General hardware

3.9. Zatvarači

Zatvarač užni za zalijevanje OSS

Open spelter socket

Min. prekidna sila (Mt)	Za užu promjera Ø (mm)	Strukturalni struk Ø (mm)	A (mm)	B (mm)	C (mm)	D (mm)	E (mm)	F (mm)	G (mm)	Ø H (mm)	Ø K (mm)	Ø P (mm)	Težina (kg/kom)
MBL	For rope dia.	Structural strand Ø	Weight										
8	6-7	-	105	46	40	19	34	9	18	10	20	17,5	0,4
12	8-10	-	122	54	45	23	40	11,2	20,6	13,5	26	20,6	0,8
20	11-13	-	142	64	51	27	48	12,7	25,6	15	30	25,4	1,1
25	14-16	12-13	171	76	63	32	56	14,5	32	18,5	38,5	30	1,9
40	18-19	14-16	205	89	76	40	68	16,5	38	22,5	46	35	3,2
55	20-22	18-19	238	101	89	48	80	20,5	45	26,8	55	41	5,3
80	23-26	20-22	273	114	101	58	98	22,5	51	29,5	62	51	8,4
100	27-30	24-26	306	127	114	65	110	25	57	34	70	57	11,3
130	31-36	27-28	338	139	127	72	124	28	63	40	83	63	16
160	37-39	30-32	394	152	162	80	140	30	76	44,5	90	70	23
200	40-42	33-35	415	165	165	85	148	33,5	76	48	97	76	29
250	43-48	36-40	467	191	178	98	170	39	89	53	112	89	43
300	49-54	42-45	552	216	228	108	186	46	101	58,5	125	95	64
375	55-60	46-48	603	229	254	120	210	53	113	68,5	135	108	85
450	61-68	50-54	654	248	273	133	230	60	127	77,5	150	121	119
500	69-75	56-62	696	279	279	138	240	73	133	83	160	127	158
600	76-80	64-67	736	305	286	145	250	76	146	89	170	133	186
650	81-86	70-73	790	330	300	160	275	79	159	95	180	140	227
750	87-93	76-80	849	356	318	175	300	82	172	99	200	152	280
900	94-102	83-92	922	381	343	198	336	89	191	110	215	178	375
1200	108-115	96-108	1110	440	450	220	370	100	205	128	250	195	525
1400	120-128	112-121	1185	490	440	255	430	113	225	143	270	220	680

2.1 2.2 CE

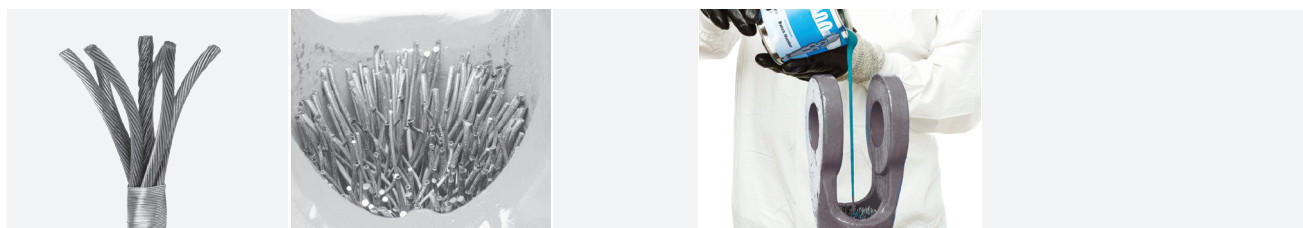
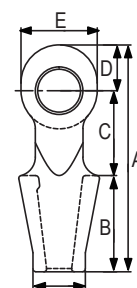
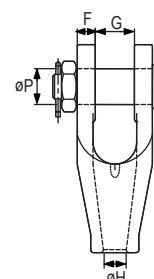

3. SPOJNI PRIBOR General hardware

3.9. Zatvarači

Zatvarač užni zatvoreni CWS

Closed wedge socket CWS type

Min. prekidna sila (Mt)	Za užje promjera (mm)	A (mm)	D (mm)	E (mm)	F (mm)	G (mm)	H (mm)	X (mm)	Težina (kg/kom)
MBL	For rope dia.								Weight
40	17-19	317	40	36	100	42	277	100	7
55	20-22	368	45	40	115	50	323	110	9
80	23-26	422	52	45	130	60	370	125	14
100	27-29	473	58	50	150	65	415	140	22
120	30-32	519	62	55	160	72	457	160	30
130	34-36	580	66	60	168	76	514	175	38
160	37-39	620	72	66	175	82	548	190	49
200	40-42	665	80	72	195	90	585	210	65
250	43-48	750	90	80	220	100	660	240	110
300	49-52	820	100	90	242	110	720	260	140
375	54-58	890	106	95	255	120	784	280	170
450	60-68	1045	120	105	280	130	925	330	240
600	72-76	1200	140	120	330	150	1060	400	380
650	81-86	1340	155	130	375	170	1185	475	490

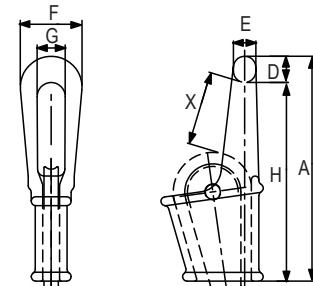

2.1 2.2 CE



• EN 13411-6

Zatvarač užni za zalijevanje APS

Anchor pendant socket

Min. prekidna sila (Mt)	Za užje promjera (mm)	A (mm)	B (mm)	C (mm)	D (mm)	E (mm)	F (mm)	G (mm)	Ø H (mm)	Ø K (mm)	Težina (kg/kom)
MBL	For rope dia.										Weight
130	31-36	270	141	88	40	36	140	82	41	60	7
160	37-42	309	162	103	44	40	152	92	46	67	11
200	43-48	369	193	123	53	48	176	110	56	74	16
250	49-54	408	210	140	58	52	200	125	58,5	83	22
320	55-60	452	230	157	65	58	226	140	68	96	31
400	61-68	499	250	174	75	66	250	156	76	107	42
500	69-75	551	280	191	80	70	275	171	80	115	54
600	76-80	591	309	196	86	76	290	180	89	125	70
700	81-86	643	332	211	100	90	304	188	94	133	85
800	87-93	685	360	220	105	95	332	210	99	142	118
900	94-102	722	375	235	112	101	366	220	110	157	142
1000	108-115	818	420	270	126	112	405	240	128	180	180
1200	120-128	920	490	290	140	126	450	276	140	200	320

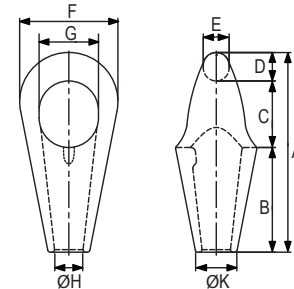

2.1 2.2 CE



3. SPOJNI PRIBOR General hardware

3.9. Zatvarači

Užni zatvarač G-6413 Green Pin

Open wedge socket G-6413

2.1 2.2 CE 

Broj	Min prekidna sila (t)	Promjer užeta (mm)	A (mm)	B (mm)	C (mm)	D (mm)	E (mm)	F (mm)	G (mm)	Težina (kg/kom)
No.	MBL	Rope dia.								Weight
0.25	8	7-8	128	110	51	18	16	9	36	0,8
0.5	12	9-10	165	142	62	20,5	21	11	46	1,5
1	20	11-13	175	146	66	25	25	12	57	2,4
2	25	14-16	211	176	82	31	30	15	70	4
3	40	18-19	252	212	95	38	35	16	80	7
4	55	20-22	288	240	110	44	41	19	95	11
5	75	24-26	329	274	130	51	51	22	110	16
6	90	27-29	375	310	145	57	57	25	130	22
7	110	30-32	423	350	155	63	64	28	146	31
8	125	34-36	474	400	163	69	64	28	148	39
9	150	37-39	527	450	178	76	70	30	153	48
10	170	40-42	580	500	187	76	76	33	160	64
11	225	43-48	650	550	226	89	89	39	186	96
12	280	49-52	745	640	257	101	95	46	194	130
13	360	54-58	785	660	275	114	108	54	230	180
14	425	60-68	970	835	300	127	121	60	250	275
15	460	72-76	1150	1000	355	146	133	76	270	440
16	625	81-86	1252	1100	375	159	140	79	300	510

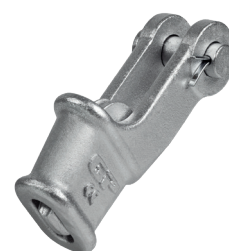
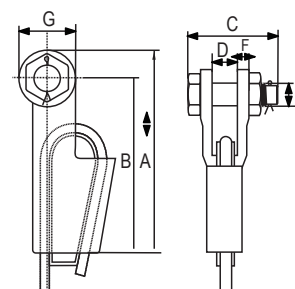

- EN 13411-6
- materijal: visokootporni čelik
- završna obrada: vruće cinčani

Užni zatvarač sa osiguračem i maticom G-6423 Green Pin

Open wedge socket with safety pin G-6423

2.1 2.2 CE 

Broj	Min. prekidna sila (t)	Promjer užeta (mm)	A (mm)	B (mm)	C (mm)	D (mm)	E (mm)	F (mm)	G (mm)	Težina (kg/kom)
No.										Weight
0,25	8	7-8	128	110	69	18	16	9	36	0,8
0,5	12	9-10	165	142	83	20,5	20	11	46	1,5
1	20	11-13	175	146	101	25	25	12	57	2,4
2	25	14-16	211	176	124	31	30	15	70	4,8
3	40	18-19	252	212	138	38	35	16	80	8,3
4	55	20-22	288	240	148	44	41	19	95	11
5	75	24-26	329	274	176	51	50	22	110	17,9
6	90	27-29	375	310	193	57	57	25	130	21
7	110	30-32	423	350	210	63	63	28	146	33
8	125	34-36	474	400	216	69	65	28	148	42
9	150	37-39	527	450	230	76	70	30	153	53
10	170	40-42	580	500	244	76	77	33	160	73

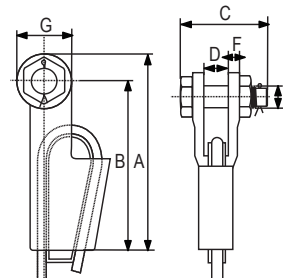

- EN 13411-6
- materijal: visokootporni čelik
- završna obrada: vruće cinčani

3. SPOJNI PRIBOR General hardware

3.10. Inox pribor

RX·lift

Škopac omega AISI 316 RX-lift

Bow shackle RX-lift

2.1

A (mm)	B (mm)	C (mm)	D (mm)	E (mm)	F (mm)
4	4	8	8	16	14
5	5	10	10	20	17
6	6	12	12	24	21
8	8	16	16	32	28
10	10	20	20	40	34
12	12	24	24	48	42
16	16	32	32	64	56
19	19	38	38	76	66
22	22	44	44	88	77

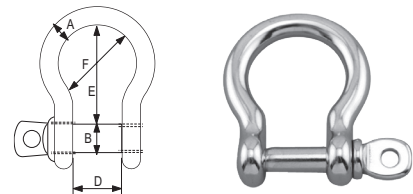

• materijal: nehrđajući čelik AISI 316

Škopac omega sa osiguračem AISI 316 RX-lift

Bow shackle with safety ring RX-lift

2.1

A (mm)	B (mm)	C (mm)	D (mm)	E (mm)	F (mm)
8	8	16	16	32	24
10	10	19	20	40	30
12	12	24	25	49	36
16	16	31	32	64	48
19	19	38	38	80	60
25	25	49	50	100	75

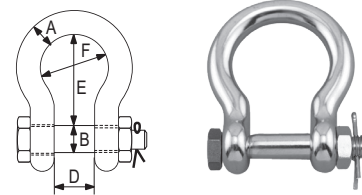

• materijal: nehrđajući čelik AISI 316

Škopac ravni AISI 316 RX-lift

Dee shackle RX-lift

2.1

A (mm)	B (mm)	C (mm)	D (mm)	E (mm)
4	4	8	8	16
5	5	10	10	20
6	6	12	12	24
8	8	16	16	32
10	10	20	20	40
12	12	24	24	48
16	16	32	32	64
19	19	38	38	76
22	22	44	44	88

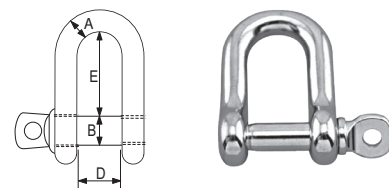

• materijal: nehrđajući čelik AISI 316

Škopac ravni sa osiguračem AISI 316 RX-lift

Dee shackle with safety ring RX-lift

2.1

A (mm)	B (mm)	C (mm)	D (mm)	E (mm)
8	8	16	16	32
10	10	19	20	40
12	12	24	25	48
16	16	31	32	64
19	19	38	38	76
25	25	49	50	95

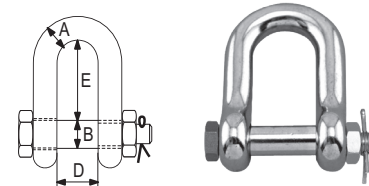

• materijal: nehrđajući čelik AISI 316

3. SPOJNI PRIBOR General hardware

3.10. Inox pribor

Škopac ravni sa imbus vijkom AISI 316 RX-lift

Dee shackle RX-lift

D (mm)	A (mm)	B (mm)	L (mm)
6	12	20	21
8	16	32	28
10	20	40	35
12	24	48	42

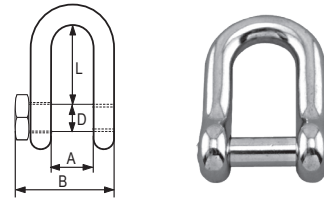

2.1

• materijal: nehrđajući čelik AISI 316

Škopac omega sa imbus vijkom AISI 316 RX-lift

Bow shackle RX-lift

Promjer Ø (mm)	A (mm)	B (mm)
5	11	23
6	12	27
8	16	36
10	21	44
12	25	52

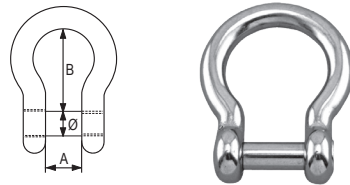

2.1

• materijal: nehrđajući čelik AISI 316

Škopac dugi AISI 316 RX-lift

Long shackle AISI 316 RX-lift

A (mm)	B (mm)	C (mm)	D (mm)	E (mm)
4	4	8	8	30
5	5	10	10	37
6	6	12	12	45
8	8	16	16	60
10	10	20	20	75

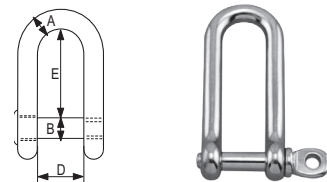

2.1

• materijal: nehrđajući čelik AISI 316

Škopac široki AISI 316 RX-lift

Dee shackle wide shape AISI 316 RX-lift

C (mm)	A (mm)	B (mm)
5	24	20
6	25	33
8	26	31
10	41	35

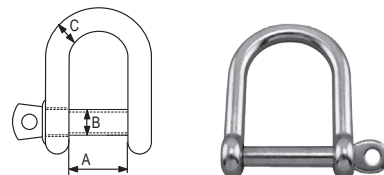

2.1

• materijal: nehrđajući čelik AISI 316

Škopac uvijeni AISI 316 RX-lift

Twisted shackle AISI 316 RX-lift

A (mm)	B (mm)	C (mm)	D (mm)	E (mm)
5	5	10	10	36
6	6	12	12	42
8	8	16	16	56
10	9,5	19	20	60
12	12	24	24	72

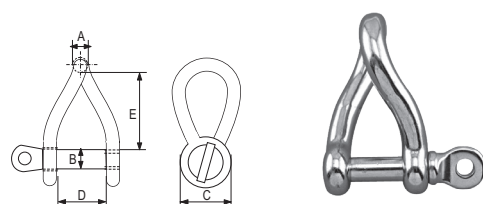

2.1

• materijal: nehrđajući čelik AISI 316

3. SPOJNI PRIBOR General hardware

3.10. Inox pribor

Stežaljka INOX AISI 316 RX-lift

Wire rope clips AISI 316 RX-lift

Promjer čel. užeta (mm)	A (mm)	B (mm)	C (mm)	D (mm)	E (mm)	F (mm)	G (mm)
Rope dia.							
3	4	20	9	12	21	10	10
4	4	22	9	12	21	10	10
5	5	24	11	13	23	11	10
6	5	28	13	15	26	12	11
8	6	34	16	19	30	14	15
10	8	42	19	22	34	18	17
13	10	55	24	30	42	23	21
16	12	63	29	33	50	26	26
19	12	75	32	38	54	29	30
22	14	85	37	44	61	33	34
26	14	95	41	45	65	35	37

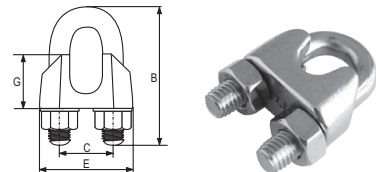

• materijal: nehrđajući čelik AISI 316

2.1

Natezni vijak kuka-oko AISI 316 RX-lift

Turnbuckle hook/eye AISI 316 RX-lift

A (mm)	B (mm)	C (mm)	D (mm)	E (mm)	F (mm)	G (mm)	H (mm)	I (mm)	J (mm)	K (mm)
M5	120	170	70	58	56	33	8	5	17	8
M6	150	210	90	73	71	43	9	6	21	10
M8	200	290	120	98	95	56	11	2	28	14
M10	240	355	150	117	118	71	12	9	34	16
M12	310	470	200	157	154	95	14	11	40	18
M16	390	590	250	186	190	116	16	15	54	26
M20	440	675	300	214	220	139	18	19	64	30

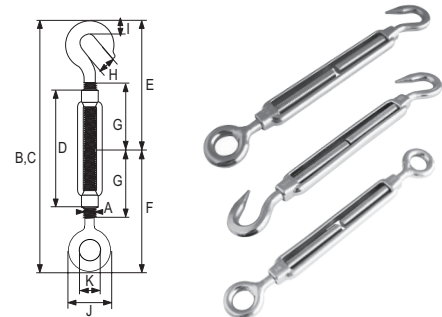

• materijal: nehrđajući čelik AISI 316

2.1

Zateznica cjevasta vilica-vilica AISI 316 RX-lift

Closed body turnbuckle jaw-jaw AISI 316 RX-lift

A (mm)	B (mm)	C (mm)	D (mm)	E (mm)	F (mm)
M5	190	125	80	5,2	6
M6	210	155	95	6,2	7,5
M8	240	180	105	8,7	10
M10	270	220	125	9,7	12
M12	360	255	150	12,7	14
M14	385	270	165	12,7	14
M16	450	320	190	16	16
M20	450	355	210	19	20

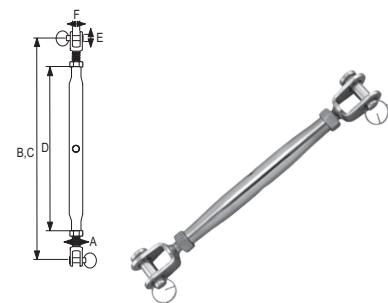

• materijal: nehrđajući čelik AISI 316

2.1

Završetak za sajlu sa okom AISI 316 RX-lift

Eye terminal AISI 316 RX-lift

Promjer čel. užeta (mm)	G (mm)	D (mm)	L1 (mm)	L2 (mm)	L3 (mm)	L4 (mm)
3	M5	11	53	36	8	34
4	M6	13	58	38	9	37
5	M6	14	65	45	9	37
6	M8	16	73	47	12	45

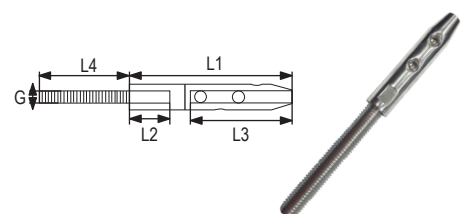

• materijal: nehrđajući čelik AISI 316

2.1

3. SPOJNI PRIBOR General hardware

3.10. Inox pribor

Završetak sa navojem AISI 316 RX-lift

Swaging terminal AISI 316 RX-lift

Navoj (mm) Thread	ø uže (mm)	L (mm)	A (mm)	B (mm)	C (mm)
M5	2,5	70	5,5	24	38
M6	2,5	72	6,3	24	40
M6	3	80	7,5	32	40
M6	4	95	7,5	40	44
M8	4	102	9	40	52
M8	5	120	9	57	52
M10	5	130	12,5	57	63
M10	6	136	12,5	63	63
M12	6	142	14,2	63	68
M12	7	148	14,2	70	68

2.1

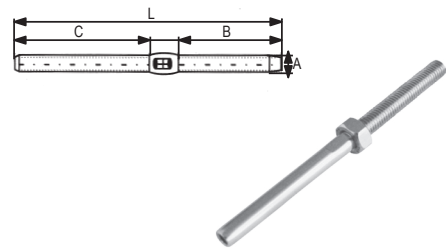

• materijal: nehrđajući čelik AISI 316

Natezni vijak vilica -terminal AISI 316 RX-lift

Turbuckle with fork and terminal AISI 316 RX-lift

A (mm)	B (mm)	C (mm)	D (mm)	E (mm)	F (mm)	G (mm)
M6	3,3	6,3	5,2	66	32	7,5
M8	4,3	7,5	6,2	77	40	10
M10	5,3	9	8,7	88	57	12
M12	6,6	12,5	9,7	106	63	14

2.1

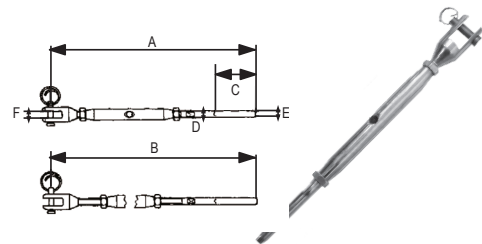

• materijal: nehrđajući čelik AISI 316

Završetak za sajlju vilica AISI 316 RX-lift

Fork terminal AISI 316 RX-lift

Promjer č. užeta (mm) Rope dia.	A (mm)	B (mm)	C (mm)	D (mm)	E (mm)	F (mm)
3	3,3	6,5	5,2	65	32	7,5
4	4,3	7,5	6,2	77	40	10
5	5,3	9	8,7	88	57	12
6	6,6	12,5	9,7	106	63	14
7	7,5	14,2	12,6	116	70	14,5
8	8,3	16	14,6	145	85	16
10	10,5	17,8	16,5	150	89	17

2.1

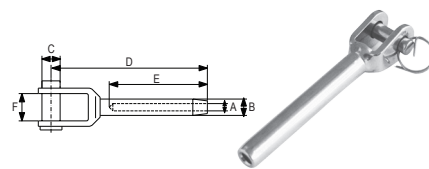

• materijal: nehrđajući čelik AISI 316

Očni vijak sa prstenom i maticom AISI 316 RX-lift

Eye bolt with nut and washer AISI 316 RX-lift

Tip	A (mm)	B (mm)	L (mm)
M6 x 40	12	22	40
M6 x 60	12	22	60
M6 x 80	12	22	80
M8 x 60	14	27	60
M8 x 80	14	27	80
M8 x 100	14	27	100
M10 x 100 1	16	31	100
M10 x 120 1	18	36	100

2.1

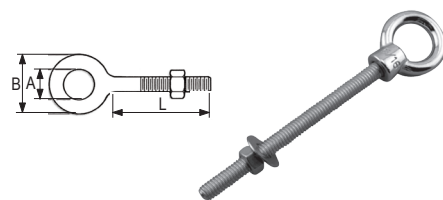

• materijal: nehrđajući čelik AISI 316

3. SPOJNI PRIBOR General hardware

3.10. Inox pribor

Spojnicica okretna sidro-lanac AISI 316 RX-lift

Power anchor chain connection AISI 316 RX-lift

Promjer lanca Ø (mm)	L (mm)	W (mm)
6-8	100	16
10-12	122	19

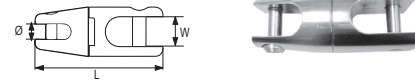

2.1

• materijal: nehrđajući čelik AISI 316

Spojnicica okretna zglobna sidro-lanac AISI 316 RX-lift

Power anchor chain connection AISI 316 RX-lift

Promjer lanca (mm)	L (mm)	W (mm)
6-8	100	16
10-12	122	19



2.1

• materijal: nehrđajući čelik AISI 316

U vijak s maticom AISI 316 RX-lift

U bolts AISI 316 RX-lift

Veličina (mm)	A (mm)	B (mm)	C (mm)	L1 (mm)	L2 (mm)
Size					
M 4 x 62	30	30	6	25	37
M 5 x 78	35	40	7	30	48
M 6 x 90	35	45	8	35	55
M 8 x 100	35	52	10	38	62
M 8 x 100	45	62	10	47	73
M 10 x 130	50	60	12	55	75
M 12 x 150	60	65	14	65	85

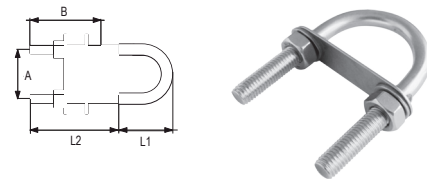

2.1

• materijal: nehrđajući čelik AISI 316

Očni vijak sa krugom AISI 316 RX-lift

Ring bolt AISI 316 RX-lift

D (mm)	L (mm)	H (mm)	T (mm)	M (mm)
6	35	75	50	6
8	45	75	50	8
10	50	100	75	10
12	60	120	80	12

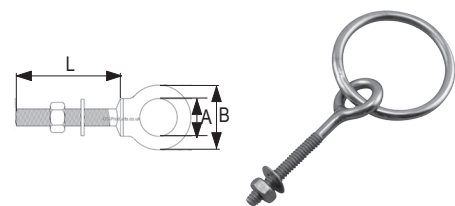

2.1

• materijal: nehrđajući čelik AISI 316

Očna matica DIN 582 AISI 316 RX-lift

Eye nut DIN 582 AISI 316 RX-lift

A (mm)	B (mm)	C (mm)	D (mm)	E (mm)	F (mm)
M 6	20	36	20	8,5	36
M 8	20	36	20	8,5	36
M 10	25	45	25	10	45
M 12	30	54	30	11	53
M 16	35	63	35	13	62

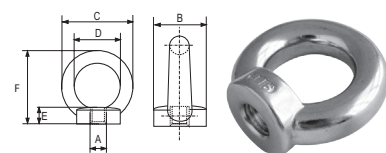

2.1

• materijal: nehrđajući čelik AISI 316

3. SPOJNI PRIBOR General hardware

3.10. Inox pribor

Očni vijak AISI 316 DIN 580 RX-lift

Eye bolt AISI 316 RX-lift

Promjer čel. užeta (mm)	A (mm)	B (mm)	C (mm)	D (mm)	E (mm)	F (mm)	g (mm)
Rope dia.							
M 6	20	36	20	13	6	36	10
M 8	20	36	20	13	6	36	10
M 10	25	45	25	17	8	45	10
M 12	30	54	30	20,5	10	53	11
M 16	35	63	35	27	12	62	15
M 20	40	72	40	30	14	71	17

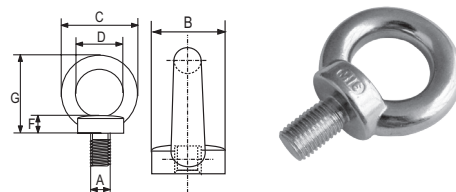

2.1

- materijal: nehrđajući čelik AISI 316

Karabiner AISI 316 RX-lift

Snap hook AISI 316 RX-lift

A (mm)	B (mm)	C (mm)	D (mm)	Prekidno opterećenje (mm)
BL				
4	40	5	7	70
5	50	7	8	110
6	60	7	9	132
7	70	9	10	198
8	80	11	12	330
9	90	11	12	363
10	100	12	15	506
11	120	14	18	660
12	140	16	20	748
13	160	20	22	880
14	180	20	22	946

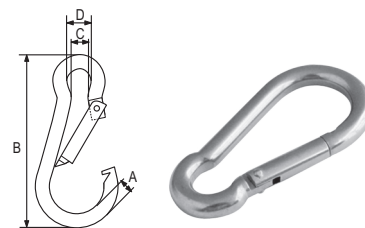

2.1

- materijal: nehrđajući čelik AISI 316

Karabiner sa osiguračem AISI 316 RX-lift

Snap hook with safety screw AISI 316 RX-lift

A (mm)	B (mm)	C (mm)	D (mm)	Prekidno opterećenje (mm)
BL				
4	40	5	7	70
5	50	7	8	110
6	60	7	9	132
7	70	9	10	198
8	80	11	12	330
9	90	11	12	363
10	100	12	15	506
11	120	14	18	660
12	140	16	20	748
13	160	20	22	880
14	180	20	22	946

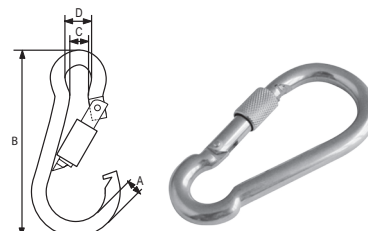

2.1

- materijal: nehrđajući čelik AISI 316

3. SPOJNI PRIBOR General hardware

3.10. Inox pribor

Karabiner sa jezgrom AISI 316 RX-lift

Snap hook with thimble AISI 316 RX-lift

2.1

A (mm)	B (mm)	C (mm)	D (mm)	Prekidno opterećenje (mm) BL
4	40	5	14	70
5	50	5	16	110
6	60	5	18	132
7	70	7	22	198
8	80	10	24	330
9	90	10	26	363
10	100	13	30	506
11	120	13	36	660
12	140	15	40	748
13	160	17	44	880
14	180	17	48	946

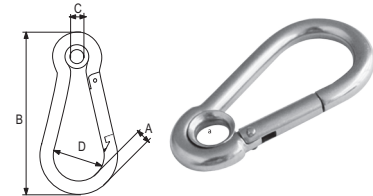

• materijal: nehrđajući čelik AISI 316

Brza spojnica lanca AISI 316 RX-lift

Quick link AISI 316 RX-lift

2.1

A (mm)	B (mm)	C (mm)	D (mm)	Prekidno opterećenje (mm) BL
3,5	10	29	5	155
4	12	32	5,5	450
5	13	39	6,5	585
6	14	46	7,5	790
8	17	59	10,5	1380
9	17	64	11,5	1790
10	20	70	12,5	2085



• materijal: nehrđajući čelik AISI 316

Beta osigurač AISI 316 RX-lift

Beta pin AISI 316 RX-lift

2.1

A (mm)	B (mm)	C (mm)	D (mm)
2	50	10	9-14
3	60	18	10-16
4	60	20	16-20
5	85	24	20-28
6	105	30	28-40
7	105	30	28-45
8	110	28	30-45

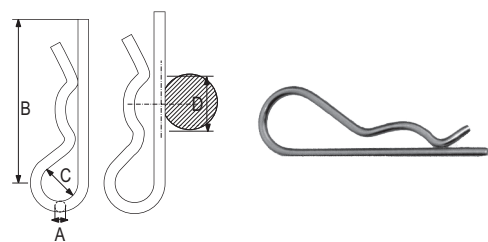

• materijal: nehrđajući čelik AISI 316

S kuka AISI 316 RX-lift

S hook AISI 316 RX-lift

2.1

D (mm)	A (mm)	B (mm)
4	38,5	21,5
5	46	26,5
6	52,5	31,5
7	61	36
8	64	44

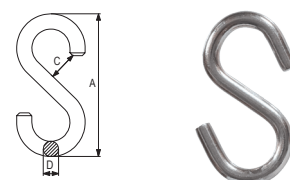

• materijal: nehrđajući čelik AISI 316

3. SPOJNI PRIBOR General hardware

3.10. Inox pribor

O karika AISI 316 RX-lift

O ring AISI 316 RX-lift

D1 (mm)	D2 (mm)
3	20
4	25
5	30
6	35
6	40
6	45
7	40
8	45
10	50

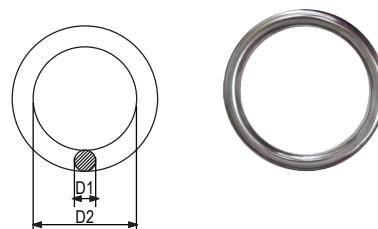

2.1

• materijal: nehrđajući čelik AISI 316

Vrtuljak oko-oko AISI 316 RX-lift

Swivel eye-eye AISI 316 RX-lift

A (mm)	B (mm)	C (mm)	D (mm)	E (mm)
5	60	13	23	13
6	65	15	26	15
8	90	22	35	20
10	115	27	44	24
13	154	35	57	32
16	188	45	71	39

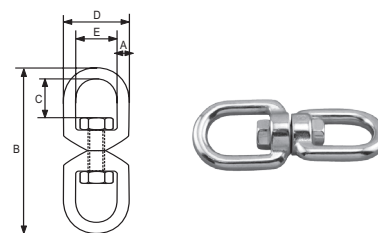

2.1

• materijal: nehrđajući čelik AISI 316

Vrtuljak oko-vilica AISI 316 RX-lift

Swivel eye-jaw AISI 316 RX-lift

D (mm)	A (mm)	B (mm)	C (mm)	Nosivost (kg) WLL
6	66	12	11	350
8	94	16	16	650
10	118	20	22	1000
13	152	26	28	1400
16	188	32	37	2500

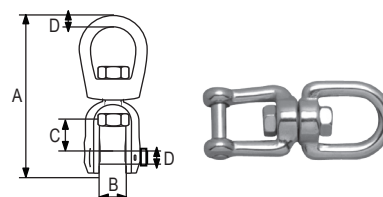

2.1

• materijal: nehrđajući čelik AISI 316

Vrtuljak vilica-vilica AISI 316 RX-lift

Swivel jaw-jaw AISI 316 RX-lift

D (mm)	A (mm)	B (mm)	C (mm)
6	66	12	11
8	94	16	16
10	118	20	22
13	152	26	28
16	188	32	37
19	229	38	45

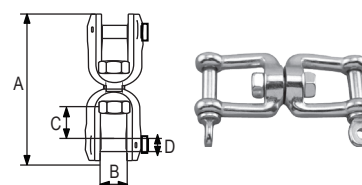

2.1

• materijal: nehrđajući čelik AISI 316

3. SPOJNI PRIBOR General hardware

3.10. Inox pribor

Jezgra AISI 316 RX-lift

Thimble AISI 316 RX-lift

A (mm)	B (mm)	C (mm)	D (mm)	E (mm)
2	9	15	23	1
2,5	9,5	15,7	24	1
3	10	16	25	1
4	11	17	28	1
5	13	20	32	1
6	16	25	39	1,2
7	18	28	40	1,2
8	20	32	49	1,4
10	26	40	55	1,9
12	28	45	70	2
14	34	56	80	2,2
16	37	62	85	2,5
18	42	65	95	2,5
20	45	78	115	3
22	50	88	125	3
24	58	96	135	4
26	66	105	140	4

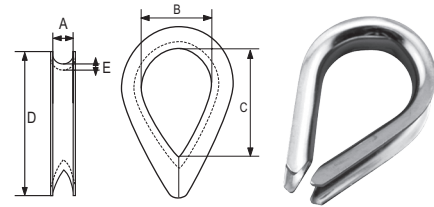

2.1

• materijal: nehrđajući čelik AISI 316

Bitva s krugom AISI 316 RX-lift

Eye plate AISI 316 RX-lift

L (mm)	B (mm)	D (mm)
45	16	11x12
65	19	14x18
81	25	19x22
100	32	24x28

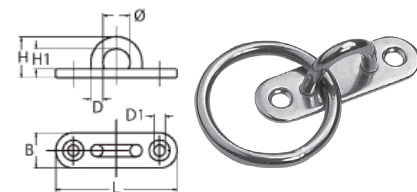

2.1

• materijal: nehrđajući čelik AISI 316

Bitva mala s podloškom i krugom AISI 316 RX-lift

Pad eye with ring AISI 316 RX-lift

D (mm)	A (mm)	B (mm)	H (mm)	L (mm)	d (mm)
5	37	59	22	35	4,2
6	40	64	26	35	4,2
8	50	80	33	45	5,2



2.1

• materijal: nehrđajući čelik AISI 316

Bitva bez podloške AISI 316 RX-lift

Wire eye strap AISI 316 RX-lift

Duljina (mm)	Debljina (mm)
40	4
50	5
60	6
63	8



2.1

• materijal: nehrđajući čelik AISI 316

3. SPOJNI PRIBOR General hardware

3.10. Inox pribor

Bitva mala AISI 316 RX-lift

Eye plate AISI 316 RX-lift

L (mm)	B (mm)	D (mm)	H (mm)	A (mm)
35	30	5	14	16
40	35	6	16	20
50	40	8	21	23

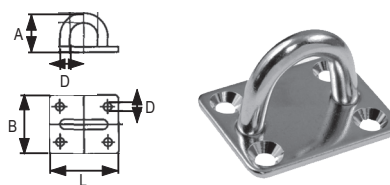

2.1

- materijal: nehrđajući čelik AISI 316

Bitva s krugom mala uska 316 RX-lift

Eye plate AISI 316 RX-lift

L (mm)	B (mm)
45	16
65	19
81	25
100	32

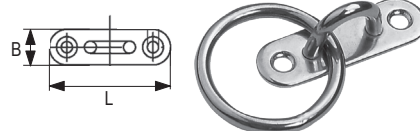

2.1

- materijal: nehrđajući čelik AISI 316

Bitva velika INOX

Stainless steel bollard



2.1

- materijal: nehrđajući čelik AISI 316
- veličine na upit