

2. PRIBOR G80 | G100 G80 and G100 accessories



2. PRIBOR G80 I G100 G80 and G100 accessories

2.1. Pribor G80

RX-lift

SVOJSTVA G80:

- kovana ili varena super legura čelika
- individualno testirano opterećenje na 2,5 x WLL
- 100% magnetna kontrola pukotina
- ispitivanje zamora na 1,5 x WLL na 20000 ciklusa
- prema standardu EN 1677
- faktor sigurnosti: 4:1
- testiranje prekidne sile
- završna obrada: plastificirana boja
- dozvoljena odstupanja u veličinama : max. do +/- 3mm

Lanac G80 EN 818-2

Chain acc. to EN 818-2, grade G80

2.1 2.2 CE BL

Promjer a	Nosivost (t)	Min. prekidna	b (mm)	c (mm)	Broj karika / 1m	Težina (kg/m)
Diameter	WLL	MBL			Links per m	Weight
6	1,12	4,48	18	22	55,5	0,78
7	1,5	6,0	21	26	47,6	1,14
8	2,0	8,0	24	30	41,6	1,5
10	3,15	12,6	30	36	33,3	2,27
13	5,3	21,2	39	47	25,6	3,74
16	8	32,0	48	58	20,8	5,54
20	12,5	50,0	60	72	16,6	8,94
22	15,0	60,0	66	79	15,1	11,57
26	21,2	86,4	78	93	12,82	15,26
32	31,5	126	96	112	10,42	22,6

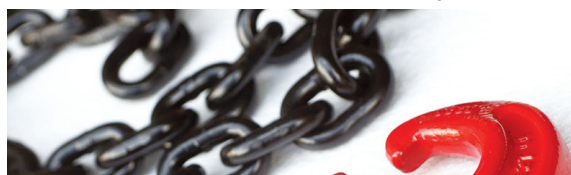
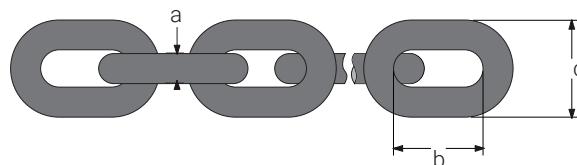

- lanac prema standardu: EN 818-2 (DIN5687)
- visokokvalitetni lanac G80 za prijenos i osiguranje tereta
- specijaliziran za dinamička i statička opterećenja
- kalibrirane karike lanca, dopuštenja odstupanja u dimenzijama samo +/-3%
- faktor sigurnosti: 4:1
- temperatura rada za: -40°C do + 200°C (WLL 100%)
- oznake dimenzije i kvalitete na karikama
- dostupni elementi za lanac G80
- završna obrada: prirodna boja ili elektroforetski lakirano

Kuka za lanac sa osiguračem G80 RX012

Clevis sling hook with cast latch G80

2.1 2.2 CE BL

Promjer lanca (mm)	Nosivost (t)	Min. prekidna sila (t)	A (mm)	B (mm)	D (mm)	H (mm)	L (mm)	E (mm)	Težina (kg/kom)
Chain dia.	WLL	MBL							Weight
6-8	1.12	4.48	8	32	35	23	76	26	0.32
7/8-8	2	8	9.5	37	37	25	86.4	29	0.48
10-8	3.15	12.6	12.5	49	46	31	104	39	0.95
13-8	5.3	21.2	16.5	56.5	56	42.5	128	47.5	1.8
16-8	8	32	21.5	70.5	60	54	150	56	3.4
18/20-8	12.5	50	24	77	79	58	180	59	6
22-8	15	60	26	91	101	62	213	72	10.4
26-8	21.2	84.8	30	117	115	75	250	101	14.5
32-8	31.5	126	35	150	140	88	317	124	27.0

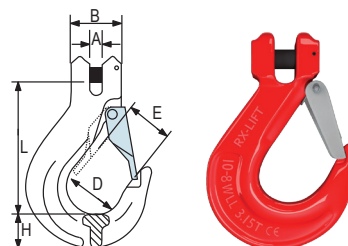

• EN 1677-2

2. PRIBOR G80 I G100 G80 and G100 accessories

2.1. Pribor G80

Kuka za lanac sa osiguračem - francuski tip G80 RX848

Clevis sling hook with latch G80

Promjer lanca (mm)	Nosivost (t)	Min. prekidna sila (t)	A (mm)	B (mm)	C (mm)	E (mm)	M (mm)	N (mm)	I (mm)	L (mm)	Težina (kg/kom)
Chain dia.	WLL	MBL									Weight
6-8	1,12	4,48	8	28,8	18	23	66	15,5	19	112	0,3
7/8-8	2	8	9	33	20	27	86	20	24,8	140	0,585
10-8	3,15	12,6	12	44	25,5	33	103	24	28	174	1,19
13-8	5,3	21,2	15	57	34	40	133,3	38	38	213,6	2,32
16-8	8	32	18,5	67	41,5	44	161	41,5	41	250	3,82
18/20-8	12,5	50	23	80	51	53	187	48	50	292	6,77

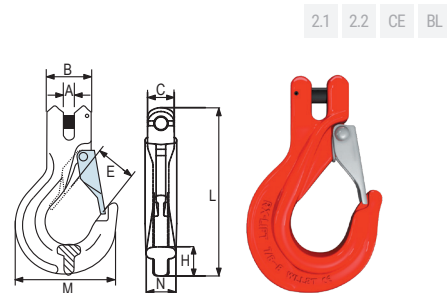

• EN 1677-2

Kuka za lanac samozatvarajuća G80 RX082

Clevis selflocking hook G80

Promjer lanca (mm)	Nosivost (t)	E (mm)	B (mm)	H (mm)	N (mm)	R (mm)	Težina (kg/kom)
Chain dia.	WLL						Weight
6-8	1,12	29	8,5	19,5	34	95,5	0,5
7/8-8	2	34	9,5	24	46	121	0,8
10-8	3,15	44	12	28,5	56	146	1,5
13-8	5,3	52	15	40	69	182	2,8
16-8	8	60	18	50,5	86	218	5,6
20-8	12,5	83	25	55	100	240	7,5
22-8	15	88	25,5	67	98	276,5	11,5
26-8	21,2	95,5	30	75	110	310,5	18,5

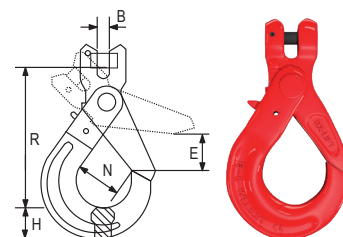

• EN 1677-3

Kuka za lanac samozatvarajuća G80 RX078

Clevis selflocking hook G80

Promjer lanca (mm)	Nosivost (t)	A (mm)	B (mm)	E (mm)	K (mm)	H (mm)	L (mm)	Φ (mm)	Težina (kg/kom)
Chain dia.	WLL								Weight
7/8-8	2	9,5	35	34	131	22	150	40	0.68
10-8	3.15	12.5	43	42	161	26	189	50	1.25
13-8	5.3	15	50	50	195.4	31	229	60	2.15
16-8	8	18.5	61	70	238	38	299	72	3.8

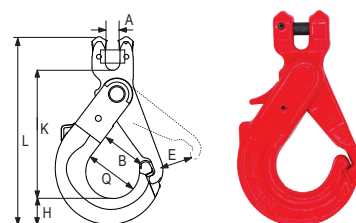

• EN 1677-3

Kuka sa okom samozatvarajuća G80 RX081

Clevis selflock eye hook G80

Promjer lanca (mm)	Nosivost (t)	M (mm)	L (mm)	D (mm)	R (mm)	H (mm)	E (mm)	Težina (kg/kom)
Chain dia.	WLL							Weight
6-8	1.12	22	110.5	10	34	19.5	28	0.5
7/8-8	2	25	136	12	46	24	34	0.8
10-8	3.15	32	171	15	56	28.5	44	1.55
13-8	5.3	40.5	208.5	19.5	69	40	52	3.2
16-8	8	56	257.5	22	86	50.5	60	5.74
20-8	12.5	64.5	275	27	100	55	81	8.5
22-8	15	70	320	30	98	67	82	13
26-8	21.2	80	363	34	110	75	110	18
32-8	31.5	105	472	45	166	97	168	44.5

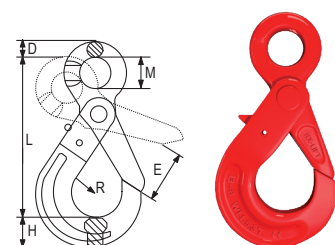

• EN 1677-3

2. PRIBOR G80 I G100 G80 and G100 accessories

2.1. Pribor G80

Kuka okretna samozatvarajuća G80 RX083

Swivel selflocking hook G80

2.1 2.2 CE BL

Promjer lanca (mm)	Nosivost (t)	B (mm)	C (mm)	D (mm)	L (mm)	T (mm)	E (mm)	Težina (kg/ kom)
Chain dia.	WLL							Weight
6-8	1,12	32,5	22	11,25	170	34	29	0,71
7/8-8	2,0	35,5	26	12,5	210	46	34	1,1
10-8	3,15	42	34	15	247	56	44	2,0
13-8	5,3	50	38,5	16	302	69	52	4,0
16-8	8,0	61	55	21,5	383	86	60	7,3
20-8	12,5	72	61	26	418	100	83	11,6
22-8	15	95	95	33	527	98	88	16,0
26-8	21,2	122	115	42	610	110	95,5	21,5
32-8	31,5	140	123	52	77	166	150	79

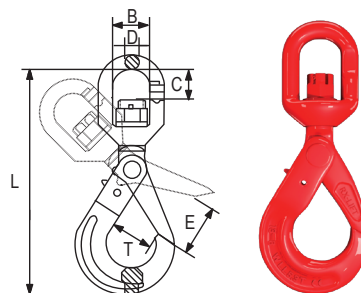

• EN 1677-3

Kuka sa osiguračem - francuski tip G80 RX315

Eye hook with latch G80

2.1 2.2 CE BL

Nosivost (t)	Min. prekidna sila (t)	A (mm)	B (mm)	E (mm)	F (mm)	H (mm)	L (mm)	Φ (mm)	Težina (kg/ kom)
WLL	MBL								Weight
1.12	4.48	20.5	21	23	15	18	114.5	18	0.31
2	8	25.5	26	29.7	19.5	23.5	138.5	23	0.56
3.15	12.6	35	37.5	34	23	27.7	163.7	38	0.99
5.3	21.2	40.5	41.5	43	32	35.5	210	45	1.85

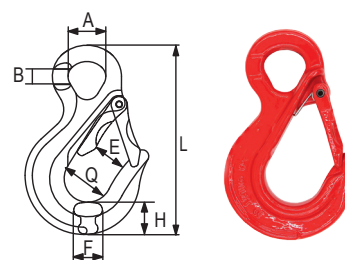

• EN 1677-2

Kuka sa okom i osiguračem G80 RX847

Eye sling hook with latch G80

2.1 2.2 CE BL

Nosivost (t)	Min. prekidna sila (t)	A (mm)	E (mm)	M (mm)	N (mm)	H (mm)	L (mm)	Težina (kg/ kom)
WLL	MBL							Weight
1,12	4,48	9,5	22	70	17	19	110	0,27
2	8	16	27	86	24	23,3	144	0,655
3,15	12,6	19	33	103	24	28	190	1,22
5,3	21,2	23	40	135,7	38	37	227	2,43
8	32	28,5	44	161	41,5	41	257	3,81
12,5	50	27	53	187	46	50	301	5,9
15	70	32	72	240	57	59,5	337	9,1

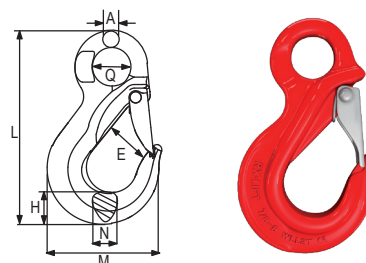

• EN 1677-2

Kuka sa okom i lijevanim osiguračem G80 RX334

Eye sling hook with cast latch G80

2.1 2.2 CE BL

Nosivost (t)	Min. prekidna sila (t)	M (mm)	D (mm)	E (mm)	H (mm)	B (mm)	L (mm)	Težina (kg/ kom)
WLL	MBL							Weight
1.12	4.48	20.5	9	18.5	20	68	109	0.3
2	8	25	11	22	27	84	133.5	0.55
3.15	12.6	34	14	28	33	102.5	167.5	1.05
5.3	21.2	42.5	17.5	35	40	128.5	207.5	1.75
8	32	52	22	43	48	156.5	253	3.2
12,5	50,0	62	26	51,5	56	187	300	60

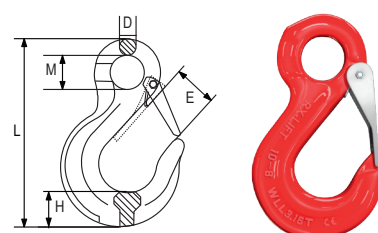

• EN 1677-2

2. PRIBOR G80 I G100 G80 and G100 accessories

2.1. Pribor G80

Kuka sa okom i lijevanim osiguračem G80 RX013

Eye sling hook with cast latch G80

2.1 2.2 CE BL

Nosivost (t)	Min. prekidna sila (t)		B (mm)	E (mm)	D (mm)	A (mm)	L (mm)	Težina (kg/kom)
	WLL	MBL						
1.12	4.48	9	24	21	20	108	0.3	
2	8	11	30	26	25	133	0.4	
3.15	12.6	15	34	39	38	167	0.9	
5.3	21.2	19	39	54	43	213	1.7	
8	32	23	46	64	50	255	3.2	
12.5	50	24	48	80	63	305	5.8	
15	60	32	71	100	62	348	8.5	
21.2	84.8	35	81	82	64	394	13	

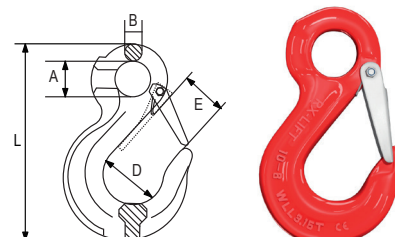

• EN 1677-2

Kuka sa osiguračem G70 320A

Eye sling hook G70 320A

2.1 2.2 BL

Nosivost 320A (t)	Min. prekidna sila (t)	D (mm)	E (mm)	H (mm)	K (mm)	L (mm)	M (mm)	Težina (kg/kom)
0,75	3,75	16	18	17	72	97	16	0,21
1,0	5,0	19	22	20,5	82	112	16	0,27
1,5	7,5	23	24,5	21,5	94	126	17,5	0,4
2,0	10,0	28	25	26	104,5	142	21	0,6
3,0	15,0	31	27	28	120	163	23	0,84
5,0	25,0	39	35,5	40	146	203	33	1,81
7,0	35,0	51	44	45	187,5	255	38	3,35
11,0	55,0	62	55	57	231,5	317	46	6,1
15,0	75,0	73	57	66	262	360	55	9,6

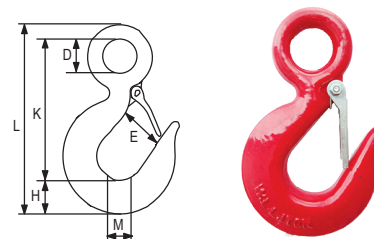

• materijal G70

Kuka sa okom i osiguračem G80 RX039

Eye sling hook with latch G80

2.1 2.2 CE BL

Nosivost (t)	Min. prekidna sila (t)	D (mm)	E (mm)	H (mm)	K (mm)	L (mm)	Težina (kg/kom)
1.12	4.48	19	22	19	80	110	0.28
2	8	28	25	25	103	140.5	0.65
3.15	12.6	31	27.5	28	118	162	0.94
5.3	21.2	39	33	35	145	201	1.95
8	32	51	40	45	180	256	3.77
12.5	50	62	51	57	230	317	6.8
15	60	73	57	70	260	360	9.8
21.2	84.8	89	75	76	318	434	16.25
31.5	126	90	98	91	360	495.5	27.2

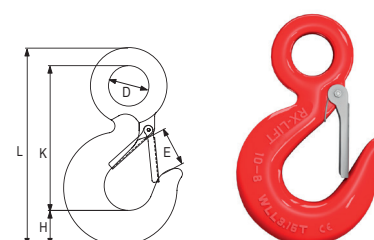

• EN 1677-2

Kuka sa osiguračem - DIN689

Eye hook with latch DIN689

2.1 2.2 BL

Nosivost (t)	B (mm)	D1 (mm)	D2 (mm)	H (mm)	L (mm)	M (mm)	Težina (kg/kom)
0,25	54	8	12	64	89	18	0,15
0,50	72	10	16	85	118	24	0,35
1,0	98	1	20	116	160	33	0,80
1,6	116	316	26	138	190	39	1,40

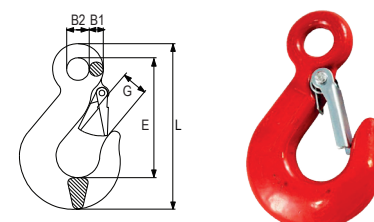

2. PRIBOR G80 I G100 G80 and G100 accessories

2.1. Pribor G80

Kuka okretna G70 322A

Swivel hook with latch G70 322A

2.1 2.2 BL

Nosivost (t)	Min. prekidna sila (t)	A (mm)	E (mm)	B (mm)	H (mm)	K (mm)	L (mm)	M (mm)	Težina (kg/kom)
WLL	MBL	Weight							
0,75	3,37	32	17	22,5	9	110	137	15	0,3
1,0	4,5	32	17	22,5	9	108	136	16	0,34
1,5	6,75	37,5	22,5	29,5	12	130	163	17,5	0,64
2,0	9,0	42,5	21,5	33	15,8	150	192	21	1,05
3,0	13,5	42,5	26	33	15,8	163	209	23	1,24
5,0	22,5	48	32,5	39	18	191	246	33	3,98
7,0	33,5	64	43	53	21,5	243	313	34	4,0
11,0	45,5	68	49,5	53	26	277	364	41,5	7,09

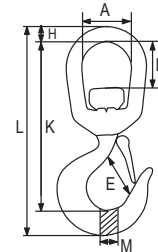

Kuka okretna G80 RX040

Swivel hook with latch G80

2.1 2.2 CE BL

Nosivost (t)	Min. prekidna sila (t)	A (mm)	E (mm)	B (mm)	H (mm)	K (mm)	L (mm)	Težina (kg/kom)
WLL	MBL	Weight						
1.12	4.48	32	17	22.5	9	109	137	0.34
2	8	42	21.5	35	15.8	150	192	1.02
3.15	12.6	42.5	26	35	15.8	162.5	208.5	1.24
5.3	21.2	48	32.5	39	18	191	246	3.6
8	32	62	43	53	25	243.5	313	4.66
12.5	50	68	49.5	51	28.5	276.5	363.5	7.4
15	60	79	54.5	65	32	332	431	10.6
21.2	84.8	105	81	114	40	429.5	545.5	21.4

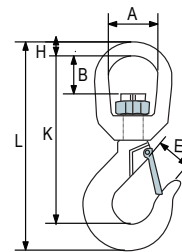

Kuka okretna sa osiguračem i ležajem G80 RX268

Swivel hook with latch G80

2.1 2.2 CE BL

Nosivost (t)	Min. prekidna sila (t)	A (mm)	B (mm)	E (mm)	H (mm)	C (mm)	L (mm)	Težina (kg/kom)
WLL	MBL	Weight						
2	8	36	88.5	27	23.5	26	190	0.85
3,15	12,6	42	104,5	32	29,5	34	233	1,54
5,3	21,2	49	135	40	38	41	291,5	3,04
8,0	32	61	161	45	45,5	53	352,0	5,36

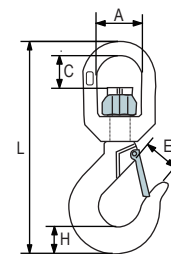

• EN 1677-2

Kuka okretna sa ležajem G80 RX788

Bearing swivel hook with latch G80

2.1 2.2 CE BL

Nosivost (t)	A (mm)	B (mm)	E (mm)	M (mm)	L1 (mm)	L (mm)	Težina (kg/kom)
WLL	Weight						
1.12	30	32.5	24	69	138	168	0.65
2	45	36	28.5	88.3	173	212	0.95
3.15	53	42	31	105	208	255	1.71
5.3	63.8	50	40.2	135	249	305.6	2.97
8	68	61	45	161	303	367	5.3
12.5	90.5	74	56	191.7	356	434.5	9.5
15	100.5	97	70	224	441	536	13.8

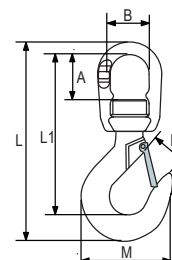

• EN 1677-2

2. PRIBOR G80 | G100 G80 and G100 accessories

2.1. Pribor G80

Skračivač lanca-kuka G80 RX085

Eye shortening cradle grab hook G80

2.1 2.2 CE BL

Promjer lanca (mm)	Nosivost (t)	Min. prekidna sila (t)	E (mm)	D (mm)	H (mm)	R (mm)	L (mm)	Težina (kg/kom)
Chain dia.	WLL	MBL						Weight
6-8	1.12	4.48	8	13.5	17.9	51.4	75.3	0.14
7/8-8	2	8	10.8	18	20	61.5	91.2	0.245
10-8	3.15	12.6	13	20	29	80	122	0.65
13-8	5.3	21.2	16.5	26	42.8	99.7	158	1.39
16-8	8	32	20	30.5	47.7	104	169	2.2
18/20-8	12.5	50	25	37.5	56	140	219	4.6
22-8	15	60	28	44	68	165	259	8.2
26-8	21.2	84.8	30	41	77	188.5	298	9.8
32-8	31.5	126	38	57	95	228	361	19.4

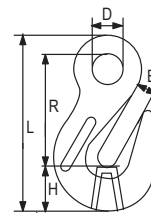

• EN 1677-1

Skračivač lanca-kuka G80 RX086

Clevis shortening grab hook G80

2.1 2.2 CE BL

Promjer lanca (mm)	Nosivost (t)	Min. prekidna sila (t)	E (mm)	A (mm)	H (mm)	W (mm)	L (mm)	Težina (kg/kom)
Chain dia.	WLL	MBL						Weight
6-8	1.12	4.48	8	8	16	26.7	75	0.25
7/8-8	2	8	10.8	9.5	21.6	33.5	90	0.32
10-8	3.15	12.6	13.5	12.5	30	46	126	0.73
13-8	5.3	21.2	16.5	15	42.5	57.5	163.5	1.6
16-8	8	32	19.2	19.5	45.5	74	183.5	2.8
18/20-8	12.5	50	24	24	56	74	219	5
22-8	15	60	27	27	68.5	90	254	6.3
26-8	21.2	84.8	30	30	77	102	309	14.5

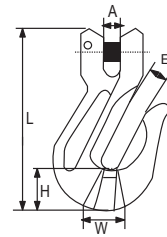

• EN 1677-1

Skračivač lanca G80 RX073

Clevis shortening clutch G80

2.1 2.2 CE BL

Promjer lanca (mm)	Nosivost (t)	Min. prekidna sila (t)	P (mm)	C (mm)	A (mm)	B (mm)	H (mm)	S (mm)	L (mm)	D (mm)	Težina (kg/kom)
Chain dia.	WLL	MBL									Weight
6-8	1.12	4.48	7.5	7.5	8	44	10.3	12	73.5	7.8	0.17
7/8-8	2	8.0	9.5	9.5	10.5	61.7	14	17	101	9.2	0.37
10-8	3.15	12.6	13	13	12.4	92	18.4	28	138	13.2	0.97
13-8	5.3	21.2	16.5	16.5	16	115	22.7	34.5	177	16.2	2.01
16-8	8	32	21	21	19.5	143	28.5	40	220	20	3.32
18/20-8	12.5	50	23.5	23.5	23	152	33.6	46	238	24.3	6.2
22-8	15	60	25.5	25.5	26	195	39	57.5	295	28.1	8.5

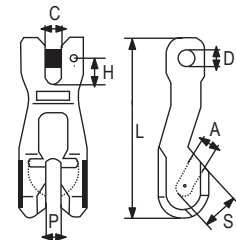

• EN 1677-1

Skračivač za lanac sa osiguračem G80 RX638

Clevis shortening clutch with safety pin G80

2.1 2.2 CE BL

Promjer lanca (mm)	Nosivost (t)	Min. prekidna sila (t)	A (mm)	B (mm)	C (mm)	D (mm)	P (mm)	L (mm)	Težina (kg/kom)
Chain dia.	WLL	MBL							Weight
7/8-8	2	8	50	9.5	33	9.5	9.2	92	0.41
10-8	3.15	12.6	60	12.5	43	12.5	13.3	115	0.75
13-8	5.3	21.2	79	15	55	15	16.3	149	1.67

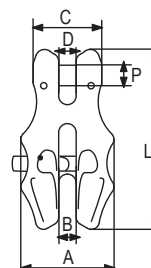

• EN 1677-1

www.remex.hr 51

2. PRIBOR G80 I G100 G80 and G100 accessories

2.1. Pribor G80

Skračivač-kuka za lanac dugi G80 RX142

Deep throat clevis shortening hook G80

2.1 2.2 CE BL

Promjer lanca (mm)	Nosivost (t)	Min. prekidna sila (t)	A (mm)	B (mm)	E (mm)	M (mm)	L (mm)	Težina (kg/kom)
Chain dia.	WLL	MBL						Weight
6-8	1.12	4.48	7.5	31.5	7.5	45	85	0.19
7/8-8	2	8	9	37.5	10	57	106	0.35
10-8	3.15	12.6	12.5	47.5	13	74	127	0.75
13-8	5.3	21.2	15	58.5	15.5	89	165.5	1.63

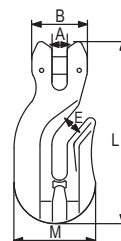

• EN 1677-1

Kuka klizna sa osiguračem G80 G80 RX072

Sliding eye choker hook G80

2.1 2.2 CE BL 

Nosivost (t)	Promjer č. užeta (mm)	A (mm)	B (mm)	C (mm)	D (mm)	E (mm)	F (mm)	G (mm)	Težina (kg/kom)
WLL	Rope dia.								Weight (kg)
0,8	6-11	112	63	19	65	14	30	16	0,4
1,6	10-13	143	82	26	83	17	30	19	0,8
2,5	14-16	170	98	30	97	19	33	25	1,2
3,2	16-20	196	115	36	110	22	40	28	1,9
5,4	22-26	260	142	46	145	36	60	35	4,3

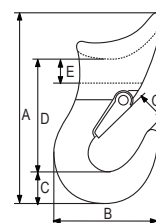

• EN 1677-1

Kuka za navarivanje G80 RX019

Weld on hook G80

2.1 2.2 CE BL

Nosivost (t)	Min. prekidna sila (t)	B (mm)	C (mm)	E (mm)	H (mm)	M (mm)	P (mm)	L (mm)	Težina (kg/kom)
WLL	MBL								Weight
1,0	5	77.6	61.3	25	93	23	25	101.6	0.49
2,0	10	92	67	28	81	23.4	34	114	0.87
3,0	15	106	73.5	30	116	30.5	36	129	1.13
5,0	25	133	94	39	159	44	43.5	171	2.5
8,0	40	137	94	36	159	44	51	177	3.26
10,0	50	170	135	48	194	54.7	53	223	5.2

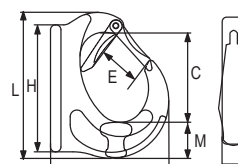

• EN 1677-1

Kuka otvorena G80 RX015

Eye foundry hook G80

2.1 2.2 CE BL

Nosivost (t)	A (mm)	D (mm)	P (mm)	K (mm)	H (mm)	T (mm)	Težina (kg/kom)
WLL							Weight
2,0	18	12	63,5	120	31	25	1,09
3,15	22	16	76	146	33	32	1,95
5,3	27	19	89	175	44,5	38	3,22
8,0	32	20	101	205	51,5	46	5,26
12,5	38	25	114	235	65	56	9,07
15,0	45	28,5	127	264	68,5	57	11,79

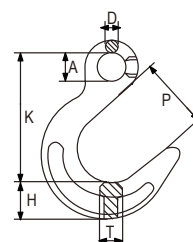

• EN 1677-1

2. PRIBOR G80 I G100 G80 and G100 accessories

2.1. Pribor G80

Spojnicna lanca VG G80 RX074

VG chain connecting link G80

2.1 2.2 CE BL

Promjer lanca (mm)	Nosivost (t)	Min. prekidna sila (t)	A (mm)	B (mm)	L (mm)	K (mm)	H (mm)	Težina (kg/ kom)
Chain dia.	WLL	MBL						Weight
6-8	1.12	4.48	15	7.5	58	42	7	0.08
7-8	1.5	6	20	8.5	73	54.8	8.5	0.145
7/8-8	2	8	20.5	9.5	79.5	60.5	8.5	0.146
8-8	2	8	20.5	9.5	79.5	60.5	8.5	0.16
10-8	3.15	12.6	26	12	90.5	68	11.5	0.30
13-8	5.3	21.2	30	15	117	87	15	0.65
16-8	8	32	35	19.8	148	108.4	19.8	1.15
18-8	10	40	38	21	154	112	21	1.84
20-8	12.5	50	41	24	169.5	121.5	24	2.1
22-8	15	60	49.5	26	193.5	141.5	26	2.87
26-8	21.2	84.8	57.5	31	220	158	30	4.5
32-8	31.5	126	67.5	38	281	205	37	8.21

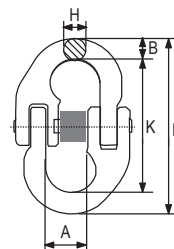

• EN 1677-1

Spojnicna lanca OMEGA G80 RX002

Omega chain connection link G80

2.1 2.2 CE BL

Promjer lanca (mm)	Nosivost (t)	Min. prekidna sila (t)	A (mm)	B (mm)	D (mm)	H (mm)	L (mm)	Težina (kg/ kom)
Chain dia.	WLL	MBL						Weight
6-8	1.12	4.48	8	41	20.5	25	52	0.12
7/8-8	2.0	8.0	10	52	23.5	35	68.5	0.22
10-8	3.15	12.6	12	62	31.5	40.5	81	0.36
13-8	5.3	21.2	15	81	41	54	108	0.71
16-8	8	32	19	99	49.5	64	126	1.3
18/20-8	12.5	50	23	118	58	75.6	152	2.2

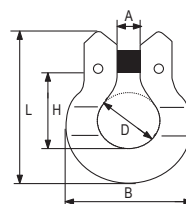

• EN 1677-1

Spojnicna poliesterske priveznice G80 RX001

Web sling connecting G80

2.1 2.2 CE BL

Nosivost (t)	Min. prekidna sila (t)	A (mm)	B (mm)	K (mm)	W (mm)	G (mm)	E (mm)	Težina (kg/ kom)
WLL	MBL							Weight
1.12	4.48	15	60	56	40	18	7	0.2
2.0	8.0	20	61.5	63.7	40	24	9.5	0.3
3.15	12.6	24	66	83	39	30.5	11	0.68
5.3	21.2	28	88	93.7	55	36.8	16.5	1.47
8	32	34.5	108	120	65.5	45.2	19.8	2.3
12.5	50	41	129	138	80	51.8	23	3.3

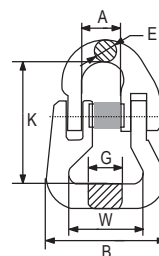

• EN 1677-1

Škopac G80 RX049

Dee shackle G80

2.1 2.2

Nosivost (t)	Min. prekidna sila (t)	A (mm)	B (mm)	D (mm)	L (mm)	Težina (kg/ kom)
WLL	MBL					Weight
2,0	8,0	15	32	9	56	0,14
3,15	12,6	21	43	11,5	71	0,27
5,3	21,2	25	51	14,5	91	0,5
8,0	32,0	30	63	17,5	111	0,89

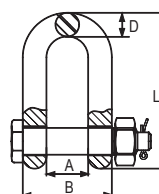

2. PRIBOR G80 I G100 G80 and G100 accessories

2.1. Pribor G80

Ovjesna alka G80 RX033 (A343)

Master link A343 G80

Nosivost (t)	A (mm)	B (mm)	D (mm)	Težina (kg/ kom)
WLL				Weight
1.6	110	60	13	0.34
2.12	110	60	16	0.54
3.15	135	75	18	0.82
5.3	160	90	22	1.5
8	180	100	26	2.3
11.2	200	110	32	3.95
14	260	140	36	6.34
17	300	160	40	8.96
21.2	340	180	45	12.8
31.5	350	190	50	16.55
45	400	200	56	23.28
56	430	220	63	32
63	460	250	72	45.76
85.46	500	270	80	62

2.1 2.2 CE BL

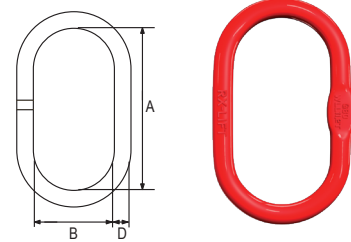

• EN 1677-1

Ovjesna alka u garnituri G80 RX094 (A347)

Master link assembly G80

Nosivost užeta (t)	A (mm)	B (mm)	D (mm)	a (mm)	b (mm)	d (mm)	s (mm)	Težina (kg/ kom)
WLL rope								Weight
2,4	100	60	14	85	40	12	6	0.82
3,2	160	90	18	100	60	14	7.6	1.6
5	160	90	20	100	60	14	7.6	1.95
8	180	100	22	150	70	18	8.4	3.16
12,0	270	140	28	160	90	22	13.5	6.75
17,4	270	140	32	180	100	25	16.5	9.31
21,2	300	160	40	270	140	31	19	18.4
26	340	180	45	285	155	36	22	26.6
31	350	190	51	340	180	45	25	42.91

2.1 2.2 CE BL

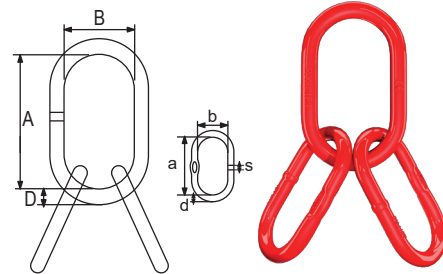

• EN 1677-1

Ovjesna alka u garnituri G80 RX488 (A346)

Master Link Assembly G80

Nosivost (t)	A (mm)	B (mm)	D (mm)	a (mm)	b (mm)	d (mm)	Težina (kg/ kom)
WLL							Weight
2.36	135	75	18	54	25	13	1.18
3.15	135	75	18	60	38	13	1.24
4.25	160	90	22	70	64	16	2.2
6.7	180	100	26	85	40	18	3.4
11.2	200	110	32	115	50	22	6.1
17	260	140	36	140	65	26	9.98
21.2	340	180	45	180	100	32	18.9
26.5	350	190	50	180	100	32	22.6
31.5	350	190	50	180	100	36	25.2
45	400	200	56	180	100	40	35.2
50	430	220	63	180	100	45	47
63	460	250	72	200	110	50	66.46

2.1 2.2 CE BL

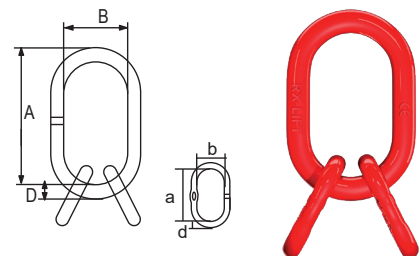

• EN 1677-1

2. PRIBOR G80 I G100 G80 and G100 accessories

2.1. Pribor G80

D ring za varenje G80 RX344

Weld on lifting D rings G80

2.1 2.2 CE

Nosivost (t)	Min. prekidna sila (t)	A (mm)	B (mm)	D (mm)	M (mm)	H (mm)	Težina (kg/ kom)
WLL	MBL	Weight					
1.12	4.48	41	78.5	13	37	35	0.4
2	8	42	88	14	40	37	0.47
3.15	12.8	45	94	17	42.5	40	0.69
5.3	21.2	55	118	22	50	52	1.46
8	32	70	141	26.5	66.5	57	2.5
10	40	85	165	28	78	66	3.2
15	60	97	188	34	90	77	5.79

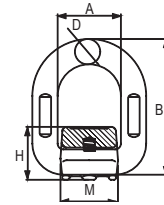

• EN 1677-1

Kuka za bačve G80 RX022

Forged carbon steel barrel hook for I

2.1 2.2

Nosivost (t)	Min. prekidna sila (t)	A (mm)	B (mm)	C (mm)	D (mm)	L (mm)	W (mm)	Težina (kg/ kom)
WLL	MBL	Weight						
1	4	109	60	38	64,5	118.5	59	0.7
2	8	102	50	40	66	128	43	0.55

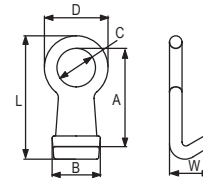

Kuka kontejnerska G80 RX633

Container lifting hook G80

2.1 2.2 CE

Nosivost (t)	Min. prekidna sila (t)	K (mm)	A (mm)	F (mm)	T (mm)	G (mm)	H (mm)	Težina (kg)
WLL	MBL	Weight						
12,5	12,5	192	70	46	25	75	48	4

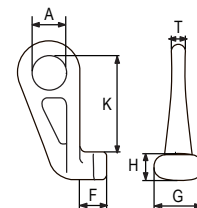

• opcije: lijeva, desna, srednja

Kuka kontejnerska Sika G80 RX0243

Container lifting clevis link G80

2.1 2.2

Nosivost (t)	Min. prekidna sila (t)	A (mm)	B (mm)	E (mm)	L (mm)	Težina (kg/ kom)
WLL	MBL	Weight				
5,3	21,2	17,6	47	53	180	1,41

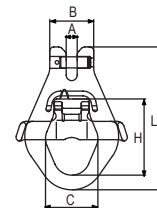

Kuka otvorena DV G80 RX023

G hook for fishing and overseas rigging G80

2.1 2.2

Nosivost (t)	Φ (mm)	B (mm)	E (mm)	H (mm)	L (mm)	Težina (kg/ kom)
WLL	Weight					
1,5	28	61	3	35	102	0,5
3,0	30	72	3	41	119	0,73
5,0	35	84,5	3	42	137	1,2
8,0	42	96	3	42	153	1,6

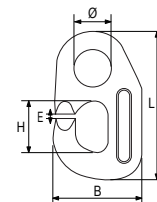

2. PRIBOR G80 I G100 G80 and G100 accessories

2.1. Pribor G80

S kuka G80 RX0101

S hook G80

2.1 2.2

Nosivost (kg)	D (mm)	A (mm)	L (mm)	S (mm)	Težina (kg/kom)
WLL	Weight				
80	8	40	150	50	0,12
160	10	40	150	50	0,2
350	14	40	150	50	0,4
630	18	40	150	50	0,68
1000	22	40	165	50	1,09
1600	26	40	175	50	1,61
2500	32	40	185	50	2,6
4000	40	50	220	65	4,6

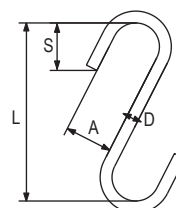

• Faktor sigurnosti: 4:1

Zatezač lanca račna G80 RX227

Ratchet chain load binder with safety hooks G80

2.1 2.2

Promjer lanca (mm)	Kapacitet povlačenja (daN)	Min. prekidna sila (t)	A (mm)	B (mm)	H (mm)	Lmin (mm)	Lmax (mm)	L (mm)	Težina (kg/kom)
Chain dia.	Lashing capacity	MBL	Weight						
8-8	4000	80.4	50	25	92	340	500	210	3.18
10-8	6300	126	50	25	118	365	525	280	5.30
13-8	10000	212	72	30	146.5	365	525	355	8.40
16-8	16000	322	72	32	178	390	550	355	8.80

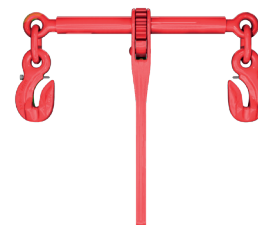
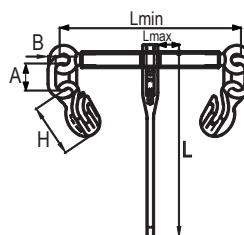

• EN 121953-3

2. PRIBOR G80 I G100 G80 and G100 accessories

2.1. Pribor G80

Očna matica G80 RX055

Eye nut G80

Nosivost na 0° (t)	Nosivost do 90° (t)	M (mm)	D (mm)	N (mm)	L (mm)	Težina (kg/ kom)
WLL 0°	WLL 90°					Weight
0,4	0,15	6	36	20	36	0,05
0,8	0,4	8	36	20	36	0,05
1,0	0,4	10	45	25	45	0,09
2,0	0,75	12	54	30	53	0,16
3,0	1,0	14	63	35	62	0,24
4,0	1,5	16	63	35	62	0,24
5,0	2,0	18	72	40	71	0,34
6,0	2,3	20	72	40	71	0,36
7,0	2,8	22	81	45	81	0,58
8,0	3,2	24	90	50	90	0,72
10	4	27	90	50	90	0,72
12	4,5	30	108	60	109	1,32

2.1 2.2 CE

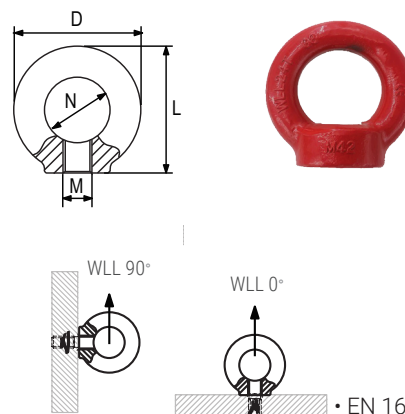

• EN 1677-1

Očni vijak G80 RX054

Eye bolt G80

Nosivost na 0° (t)	Nosivost do 90° (t)	M (mm)	D (mm)	K (mm)	N (mm)	L (mm)	Težina (kg/ kom)
WLL 0°	WLL 90°						Weight
0,4	0,15	6	28	13	16	42	0,05
0,8	0,4	8	36	15	20	51	0,06
1,0	0,4	10	45	18	25	63	0,11
20,0	0,75	12	54	22	30	75	0,18
3,0	1,0	14	63	28	35	89,5	0,28
4,0	1,5	16	63	28	35	90	0,29
5,0	2,0	18	72	30	40	101	0,42
6,0	2,3	20	72	30	40	101	0,45
7,0	2,8	22	81	34,5	45	115	0,67
8,0	3,2	24	90	38	50	128	0,87
10	4,0	27	90	38	60	128	0,88
12	4,5	30	108	45	60	154	1,66

2.1 2.2 CE

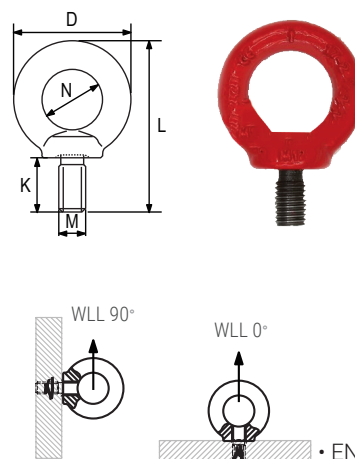

• EN 1677-1

Vijak sa okom G80 tip AL

Lifting eye type AL G80

Nosivost (t)	A (mm)	B (mm)	C (mm)	D (mm)	E (mm)	F (mm)	G (mm)	Težina (kg/ kom)
WLL								Weight
0,2	M6x1,0	20	34	20	20	17	7	0,05
0,4	M8x1,25	20	34	20	24	17	7	0,07
0,7	M10x1,5	20	38	22	30	19	8	0,08
1,0	M12x1,75	25	47	27	36	23	10	0,14
1,2	M14x2,0	30	57	30	40	27	14	0,25
1,5	M16x2,0	36	63	35	53	31	14	0,39
2,0	M18x2,5	36	63	35	53	31	14	0,38
2,5	M20x2,5	40	72	40	58	34	16	0,58
3,0	M22x2,5	42	82	45	64	38	19	1,01
4,0	M24x3,0	55	95	55	84	40	20	1,12
5,0	M27x3,0	55	95	55	84	40	20	1,18
6,0	M30x3,5	60	108	60	99	49	24	1,84 e

2.1 2.2 CE

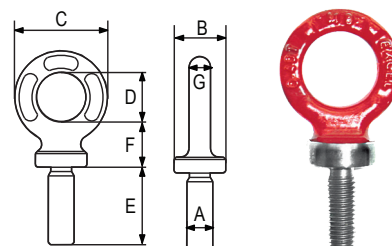

• EN 1677-1

2. PRIBOR G80 | G100 G80 and G100 accessories

2.1. Pribor G80

Okretni vijak s alkom G80 RX303

Screw point G80

2.1 2.2 CE

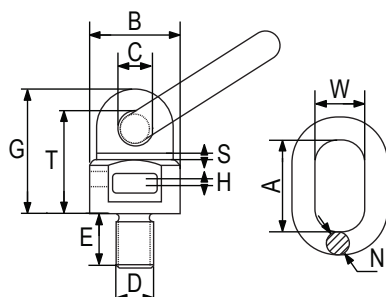

• EN 1677-1

Veličina (mm)	Nosivost (t) na 90°	Nosivost (t) na 0°	DxE (mm)	B (mm)	C (mm)	G (mm)	T (mm)	A (mm)	W (mm)	N (mm)	H (mm)	S (mm)	Težina (kg/kom)
Item No.	WLL 90°	WLL 0°											Weight
M8	0.3	0.6	M8X13	36	16.5	51	41	55	30	14	3	1	0.41
M10	0.5	0.9	M10x18	36	16.5	51	41	55	30	14	3	1	0.43
M10X90	0.5	1.0	M10X90	36	16.5	51	41	55	30	14	3	1	0.38
M12	0.5	1.0	M12x18	36	16.5	51	41	55	30	14	3	1	0.44
M12x40	0.5	1.0	M12x40	36	16.5	51	41	55	30	14	3	1	0.52
M12x45	0.5	1.0	M12x45	36	16.5	51	41	55	30	14	3	1	0.47
M12x110	0.5	1.0	M12x110	36	16.5	51	41	55	30	14	3	1	0.53
M14	1.12	2.0	M14X20	36	16.5	51	41	55	30	14	3	1	0.45
M16	1.12	2.0	M16X35	36	16.5	52	42	55	30	14	3	1	0.46
M16X40	1.12	2.0	M16X40	36	16.5	52	42	55	30	14	3	1	0.48
M16X100	1.12	2.0	M16X100	36	16.5	52	42	55	30	14	3	1	0.54
M16X120	1.12	2.0	M16X120	36	16.5	52	42	55	30	14	3.5	1	0.6
M20	2	4	M20X30	49.5	19	68	56	70	35	16	3.5	1	0.96
M20X120	2	4	M20X120	49.5	19	68	56	70	35	16	3.5	1	1.17
M24	3.15	6.3	M24X40	57	22	78	65.5	85	40	18	3.5	1.5	1.45
M24X40	3.15	6.3	M24x90	57	22	78	65.5	85	40	18	3.5	1.5	1.42
M24X90	3.15	6.3	M24x90	57	22	78	65.5	85	40	18	3.5	1.5	1.66
M24X120	3.15	6.3	M24X120	57	22	78	65.5	85	40	18	3.5	1.5	1.74
M27	3.15	6.3	M27X35	57	22	78	65.5	85	40	20	3.5	1.5	1.47
M30(5T)	5.3	10.6	M30X35	66	23.5	96.5	80.5	85	40	20	4	1.5	2.17
M30x38	5.3	10.6	M30X38	66	23.5	96.5	80.5	85	40	20	4	1.5	2.18
M30x120	5.3	10.6	M30X120	66	23.5	96.5	80.5	85	40	22	4	1.5	2.65
M30(8T)	8	11.8	M30X35	80	28	112	92	115	50	22	6	2	3.57
M30x38	8	11.8	M30X38	80	28	112	92	115	50	22	6	2	3.58
M30x120	8	11.8	M30x120	80	28	112	92	115	50	22	6	2	4.01
M36x90	8	11.8	M36X90	80	27	109	89.5	115	50	22	6	2	4.17
M36x400	8	11.8	M36x400	80	27	109	89.5	115	50	22	6	2	6.41
M39	8	11.8	M39x50	80	27	109	89.5	115	50	22	6	2	3.65
M39x90	8	11.8	M39X90	80	27	109	89.5	115	50	22	6	2	3.71
M42	10	15	M42X50	80	27	109	89.5	115	50	25	6	2.5	3.62
M42X60	10	15	M42X60	80	27	109	89.5	115	50	25	6	2.5	3.72
M42X130	10	15	M42X130	80	27	109	89.5	115	50	25	6	2.5	4.46
M42X180	10	15	M42X180	80	27	109	89.5	115	50	25	6	2.5	5.0
M45X60	10	15	M45X60	80	27	109	89.5	115	50	25	6	2.5	4.17
M48	10	15	M45X50	80	27	109	89.5	115	50	25	6	2.5	4.02
M48X110	10	15	M48X110	80	27	109	89.5	115	50	25	6	2.5	4.8
M56X84	15	25	M56X84	117	42	310	280	152	70	32	7	2.5	11.6
M64X95	15	25	M64X95	117	42	310	280	152	70	32	7	2.5	12.4

2. PRIBOR G80 I G100 G80 and G100 accessories

2.1. Pribor G80

Okretni vijak sa ležajem G80 RX173

Lifting pivoting point G80

2.1 2.2 CE

Navoj	Nosivost na 0° (t)	Prekidna sila (t)	A (mm)	B (mm)	C (mm)	D (mm)	E (mm)	M (mm)	L (mm)	L' (mm)	φ (mm)	Težina (kg/kom)
Thread	WLL 0°	BL										Weight
M8	0.3	1.2	35	52.5	6	30	13	45	46	10.4	14	0.36
M8x76	0.3	1.2	35	52.5	6	30	13	45	46	76	14	0.39
M10	0.63	2.52	35	52.5	6	30	17	45	52	16	14	0.38
M10x96	0.63	2.52	35	52.5	6	30	17	45	52	96	14	0.43
M12	1	4	40	54	8	36	19	68	62	18	18	0.71
M12x114	1	4	40	54	8	36	19	68	158	114	18	0.8
M14	1.2	4.8	40	54	8	36	19	68	66	21	18	0.72
M14x140	1.2	4.8	40	54	10	36	22	68	185	140	18	0.86
M16	1.5	6	40	54	8	36	19	68	70	24	18	0.74
M16x30	1.5	6	40	54	8	36	19	68	70	30	18	0.74
M16x40	1.5	6	40	54	8	36	19	68	70	40	18	0.75
M16x100	1.5	6	40	54	10	36	24	68	146	100	18	0.85
M16x149	1.5	6	40	54	10	36	24	68	195	149	18	0.92
M16x194	1.5	6	40	54	10	36	24	68	240	194	18	0.99
M18x26	2	8	54	80	12	50	30	83	83	26	16	1.16
M18x180	2	8	54	80	12	50	30	83	237	180	16	1.47
M20	2.5	10	54	80	12	50	30	83	88	30	16	1.19
M20x55	2.5	10	54	80	12	50	30	83	113	55	16	1.21
M20x60	2.5	10	54	80	12	50	30	83	118	60	16	1.25
M20x100	2.5	10	54	80	12	50	30	83	156	100	16	1.57
M20x187	2.5	10	54	80	12	50	30	83	118	187	16	2.27
M24x35	4	16	54	94	14	50	36	83	95	35	18	1.35
M24x40	4	16	54	94	14	50	36	83	100	40	18	1.38
M24x60	4	16	54	94	14	50	36	83	120	60	18	1.46
M24x80	4	16	54	94	14	50	36	83	138	80	18	1.54
M24x100	4	16	54	94	14	50	36	83	158	100	18	1.62
M24x222	4	16	54	94	14	50	36	83	120	222	18	2.11
M27	4	16	73	106	17	68	41	120	120	38	27	4.18
M27x270	4	16	73	106	17	68	41	120	352	270	27	5.22
M30	5	20	73	106	17	68	41	120	132	48	27	4.4
M30x70	5	20	73	106	17	68	41	120	154	70	27	4.19
M30x279	5	20	73	106	17	68	41	120	154	279	27	5.35
M36x54	7	28	73	106	17	68	41	120	142	54	27	4.65
M36x62	8	32	94	140.5	22	86	55	156	163	62	31	7.6
M36x70	7	28	73	106	17	68	41	120	158	70	27	4.8
M36x223	8	32	94	140.5	22	86	55	156	324	223	31	8.94
M42	10	40	94	140.5	24	86	65	156	176	72	31	8.2
M42x63	15	60	104	155	24	95	65	176	179	63	40	12.4
M42x263	15	60	104	155	24	95	65	176	379	263	40	14.6
M48x74	20	80	104	155	24	95	75	176	194	74	40	13
M48x295	20	80	104	155	24	95	75	176	194	295	40	16.1

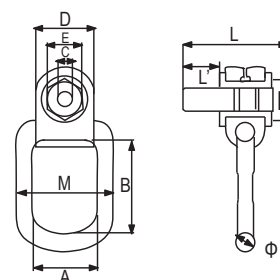

• EN1677-1



2. PRIBOR G80 I G100 G80 and G100 accessories

2.2. Pribor G100

RX-lift

SVOJSTVA G100:

- kovana ili varena super legura čelika
- 25% čvršće od razreda G80
- individualno testirano opterećenje na 2,5 x WLL
- 100% magnetna kontrola pukotina
- ispitivanje zamora na 1,5 x WLL na 20000 ciklusa
- prema standardu EN 1677
- faktor sigurnosti: 4:1
- testiranje prekidne sile
- završna obrada: plastificirana boja
- dozvoljena odstupanja u veličinama : max. do +/- 3mm

Ovjesna alka za lanac G100 RX1013

Master link G100

2.1 2.2 CE BL

Nosivost (t)	Min. prekidna sila(t)	A (mm)	B (mm)	D (mm)	Težina (kg/ kom)
WLL	MBL	A	B	D	Weight
2.5	10	120	70	14	0.4
4	16	140	80	17	0.7
7.5	30	160	95	22	1.5
10	40	190	110	28	2.2
17	68	240	140	34	5.1
28	100	250	150	42	7.2

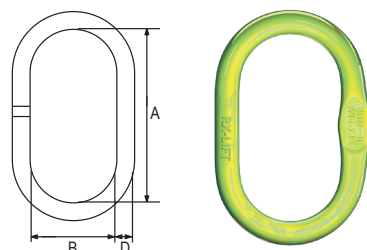

Ovjesna alka u garnituri G100 RX1012

Master link assembly G100

2.1 2.2 CE BL

Nosivost (t)	Min. prekidna sila(t)	A (mm)	B (mm)	D (mm)	a (mm)	b (mm)	d (mm)	Težina (kg/ kom)
WLL	MBL	A	B	D	a	b	d	Weight
3	12	135	75	19	84	25	13	1.3
5.3	21.2	160	90	23	70	34	16.5	2.33
8	32	180	100	27	85	40	19	3.7
14	56	200	110	33	115	50	23	6.5
21.2	84.8	260	140	36	140	65	27	10.1
33.6	--	350	190	50	150	70	33	24.15
39.9	--	350	190	50	180	100	36	26

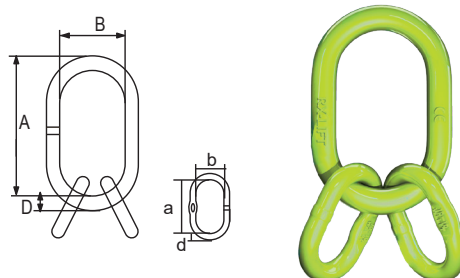

Kuka skraćivač sa okom za lanac G100 RX1051

Grab hook with clevis attachment G100

2.1 2.2 CE MD

Promjer lanca (mm)	Nosivost (t)	Min. prekidna sila(t)	Φ (mm)	A (mm)	B (mm)	C (mm)	L1 (mm)	L (mm)	Φ' (mm)	D (mm)	Težina (kg/ kom)
Chain dia.	WLL	MBL	Φ	A	B	C	L1	L	Φ'	D	Weight
6-10	1.4	5.6	18	8	32	8	88	112	9	17.5	0.3
8-10	2.5	10	24	10	36	10	116	145	12	23	0.69
10-10	4	16	30	12.5	48	12.5	145	184	15	28.5	1.33
13-10	6.7	26.8	37	15.5	59.5	15.5	178	223	18	35	2.36
16-10	10	40	45	19	70	19	216	273	22	42	4.5
20-10	16	64	58	24.5	85	24.5	278	351	28	52	9

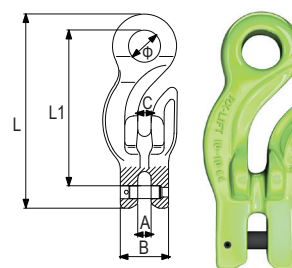

2. PRIBOR G80 I G100 G80 and G100 accessories

2.2. Pribor G80

Ovjesna alka sa skraćivačem za lanac 2-krake priveznice G100 RX1067

Master link + eye grab hook with clevis attachment x 2 G100

Nosivost (t)	Promjer lanca (mm)	A (mm)	B (mm)	φD	Dio 1	Skraćivač
WLL	Chain dia.				Fitting 1	Fitting 2
2,0	6-10	120	70	14	Ovjesna alka	RX1051 6-10 x2
3,55	8-10	140	80	17	Ovjesna alka	RX1051 8-10 x2
5,6	10-10	160	95	22	Ovjesna alka	RX1051 10-10 x2
9,5	13-10	190	110	25	Ovjesna alka	RX1051 13-10 x2
14,0	16-10	230	130	32	Ovjesna alka	RX1051 16-10 x2

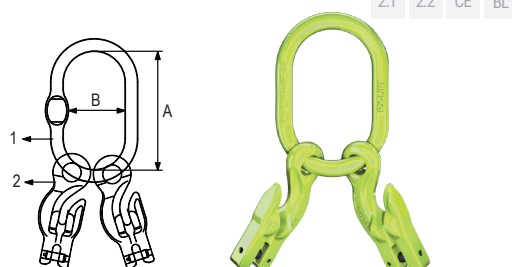

2.1 2.2 CE BL

• EN 1677-1

Ovjesna alka sa skraćivačem za lanac 3 i 4-krake priveznice G100 RX1068

Master link + eye grab hook with clevis attachment x 4 G100

Nosivost (t)	Promjer lanca (mm)	Ovjesna alka u garnituri	Skraćivač
WLL	Chain dia.	Fitting 1	Fitting 2
3,0	6-10	RX1012 6-10	RX1051 6-10 x4
5,3	8-10	RX1012 8-10	RX1051 8-10 x4
8,0	10-10	RX1012 10-10	RX1051 10-10 x4
14,0	13-10	RX1012 13-10	RX1051 13-10 x4
21,0	16-10	RX1012 16-10	RX1051 16-10 x4

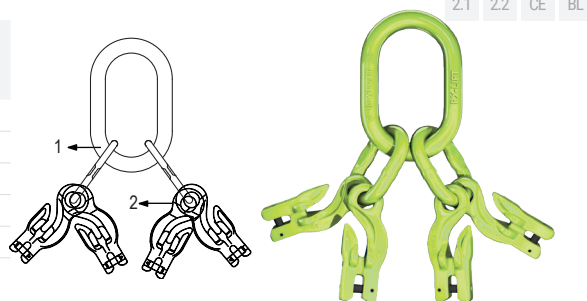

2.1 2.2 CE BL

• EN 1677-1

Kuka za poliestersku priveznicu s osiguračem G100 RX1055

Web sling hook with safety lock G100

Nosivost (t)	Min. prekidna sila (t)	A (mm)	B (mm)	C (mm)	M (mm)	E (mm)	E' (mm)	L (mm)	L' (mm)	H (mm)	Težina (kg/kom)
WLL	MBL										Weight
1,0	4	11.5	40	78	75.7	34	30	124	87	21	0,73
2,0	8	18.5	44.5	91	90	40	39	148	103	27	1.27
3,0	12	21	54	113	110	40	47	175	115	33	2,3
4,0	16	40,5	76,5	133	139	50	60	223	147	40,5	4,615
5,0	20	40,5	76,5	133	139	50	60	223	147	40,5	4,615
6,0	24	40,5	76,5	133	139	50	60	223	147	40,5	4,615

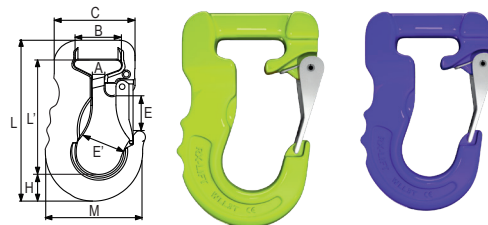

2.1 2.2 CE BL

• EN 1677-1

Zatezač lanca račna sa skraćivačima G100 RX1030

Ratchet load binder with eye grab hook and safety pin G100

Promjer lanca (mm)	Kapacitet povlačenja (daN)	Min. prekidna sila (kN)	A (mm)	D (mm)	H (mm)	E (mm)	L (mm)	P (mm)	Lmin (mm)	Lmax (mm)	Težina (kg/kom)
Chain dia.	LC	MBL									Weight
8-10	5000	100	50	12	98	10.5	383	56	340	500	3.71
10-10	8000	160	50	14	121.5	13	390	65	365	525	5.85
13-10	13400	268	72	20	159.5	15.5	392.5	69	365	525	9.34

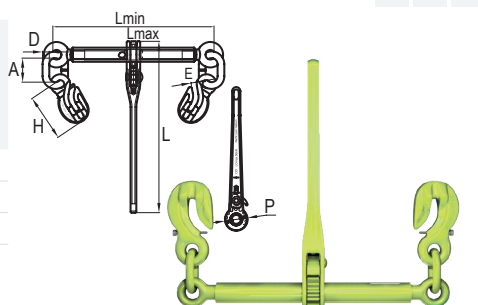

2.1 2.2 CE

• EN 12195-3

www.remex.hr 61

2. PRIBOR G80 I G100 G80 and G100 accessories

2.2. Pribor G100

Rezervni dijelovi

Hook spare parts

Rezervni dijelovi kuka i spojnice

Spare parts

	Rezervni dio za kuke, komplet osigurača		Rezervni dio kuka za lanac, komplet osigurača		Rezervni dio kuka za lanac, komplet osigurača
	Rezervni dio samozatvarajućih kuka, komplet osigurača		Rezervni dio kuka za lanac, svornjak		Rezervni dio spojnice lanca, svornjak

2. PRIBOR G80 I G100 G80 and G100 accessories

2.2. Pribor G100

GUNNEBO

Lanac prema EN 818-2 G100

Chain according to EN 818-2, G100

2.1 2.2 CE BL

Promjer a (mm)	Nosivost (t)	Min. prekidna sila (kN)	b (mm)	c (mm)	Težina (m/kg)
Diameter	WLL	MBL			Weight
6	1,5	58,9	18	20,5	0,87
7	1,95	77	21	24,0	1,14
8	2,6	102	24	27,0	1,45
10	4,0	158	30	34,0	2,25
13	6,8	268	39	43,7	3,76
16	10,3	402	48	53,9	5,64
20	16,0	630	60	67,0	9,4
22	20,0	785	66	73,0	11,9
26	27,0	1062	78	87,0	16,4
32	40,0	1610	96	105,6	25,8

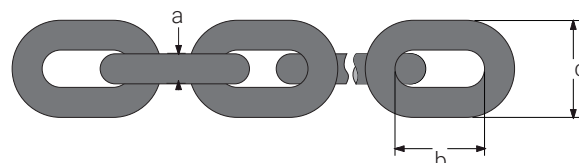

- lanac prema standardu: EN 818-2
- visokokvalitetni lanac za prijenos i vuču tereta
- 25% jači od lanca G80
- specijaliziran za dinamička i statička opterećenja
- kalibrirane karike lanca
- faktor sigurnosti: 4:1
- temperatura rada za: -40°C do + 200°C (WLL 100%)
- dostupni elementi za lanac G100
- završna obrada: plastificirani plavi



2. PRIBOR G80 I G100 G80 and G100 accessories

2.2. Pribor G100

GUNNEBO

Kuka za lanac sa osiguračem G100 EGKN

Clevis hook with latch G100

2.1 2.2 3.1 CE BL

Promjer lanca (mm)	Nosivost (t)	L (mm)	B (mm)	G (mm)	H (mm)	Težina (kg/kom)
Chain dia.	WLL	Weight				
6-10	1,5	86	25	17	20	0,4
7-10	2,0	95	27	17	23	0,5
8-10	2,6	95	28	17	23	0,5
10-10	4,0	121	35	23	31	1,0
13-10	6,8	145	42	28	38	2,2
16-10	10,3	170	53	36	46	4,0
20-10	16,0	209	65	42	60	7,6

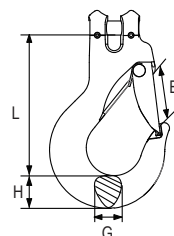

Kuka za lanac samozatvarajuća G100 BKG

Clevis self-locking hook G100

2.1 2.2 3.1 CE BL

Promjer lanca (mm)	Nosivost (t)	L (mm)	B (mm)	G (mm)	H (mm)	Težina (kg/kom)
Chain dia.	WLL	Weight				
6-10	1,5	91	29	15	21	0,5
7-10	2,0	120	37	17	22	0,5
8-10	2,6	121	37	17	26	0,9
10-10	4,0	144	45	21	31	1,5
13-10	6,8	180	55	30	40	3,0
16-10	10,3	219	62	37	50	5,5
20-10	16,0	240	68	44	62	9,6

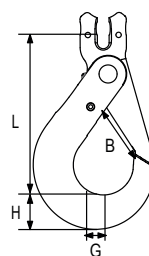

Kuka sa okom samozatvarajuća G100 BK

Eye self-locking hook G100

2.1 2.2 3.1 CE BL

Promjer lanca (mm)	Nosivost (t)	A (mm)	L (mm)	B (mm)	E (mm)	F (mm)	G (mm)	H (mm)	Težina (kg/kom)
Chain dia.	WLL	Weight							
6-10	1,5	12	109	29	22	10	15	21	0,5
7/8-10	2,6	14	138	37	28	11	17	26	0,9
10-10	4,0	16	168	45	34	13	21	31	1,5
13-10	6,8	20	207	55	44	16	30	40	3,0
16-10	10,3	26	254	62	56	20	37	50	5,5
18/20-10	16,0	30	289	68	60	22	44	64	9,0
22-10	20,0	32	320	80	70	24	50	64	11,3
26-10	27,3	35	342	100	80	25	54	68	16,5

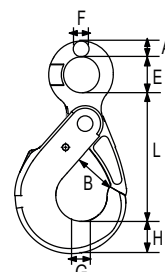

Kuka okretna samozatvarajuća G100 BKL

Swivel eye self-locking hook G100

2.1 2.2 3.1 CE BL

Promjer lanca (mm)	Nosivost (t)	L (mm)	B (mm)	C (mm)	E (mm)	A (mm)	G (mm)	H (mm)	Težina (kg/kom)
Chain dia.	WLL	Weight							
6-10	1,5	149	29	23	33	11	15	21	0,7
7/8-10	2,6	183	37	27	38	12	17	26	1,2
10-10	4,0	218	45	37	44	15	21	31	2,0
13-10	6,8	282	55	49	48	19	30	40	4,0
16-10	10,3	341	62	65	61	25	37	50	7,2
18/20-10	16,0	368	68	70	72	31	44	62	11,4

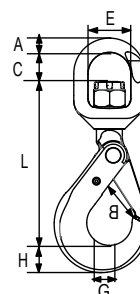

2. PRIBOR G80 I G100 G80 and G100 accessories

2.2. Pribor G100

GUNNEBO

Kuka sa okom i osiguračem G100 EKN

Sling hook with latch G100

2.1 2.2 3.1 CE BL

Promjer lanca (mm)	Nosivost (t)	L (mm)	B (mm)	E (mm)	F (mm)	G (mm)	H (mm)	Težina (kg/ kom)
Chain dia.	WLL							Weight
6-10	1,5	93	25	23	10	17	20	0,4
7/8-10	2,6	108	26	28	12	17	23	0,6
10-10	4,0	134	37	34	14	23	30	1,0
13-10	6,8	166	42	44	18	28	38	2,1
16-10	10,3	203	53	56	22	36	47	40,0
20-10	16,0	229	60	61	26	42	60	6,4
22-10	20,0	267	73	64	31	43	67	8,9
26-10	27,3	301	82	66	32	51	75	13,0
32-10	40,0	353	96	90	38	61	98	25,0

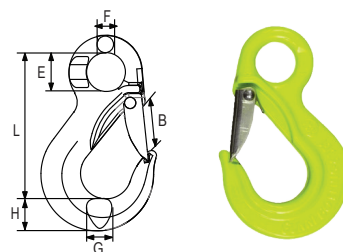

Kuka za lanac samozatvarajuća G100 BKGC

Clevis sling hook for skip loaders G100

2.1 2.2 3.1 CE BL

Promjer lanca (mm)	Nosivost (t)	L (mm)	B (mm)	G (mm)	H (mm)	Težina (kg/ kom)
Chain dia.	WLL					Weight
13-10	6,8	164	55	27	43	3,2

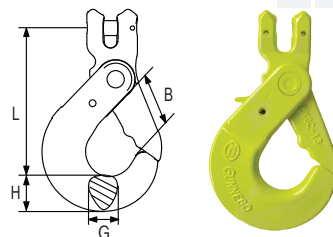

Skračivač lanca-kuka za lanac G100 GG

Clevis grab hook G100

2.1 2.2 3.1 CE BL

Promjer lanca (mm)	Nosivost (t)	L (mm)	B (mm)	Težina (kg/ kom)
Chain dia.	WLL			Weight
6-10	1,5	54	8	0,2
7-10	2,0	57	10	0,3
8-10	2,6	57	10	0,4
10-10	4,0	76	12	0,9
13-10	6,8	97	16	1,8
16-10	10,3	114	20	3,1
20-10	16,0	147	26	7,0

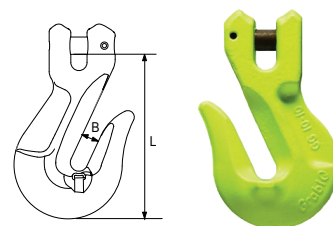

Skračivač lanca-kuka sa okom G100 OG

Eye grab hook G100

2.1 2.2 3.1 CE BL

Promjer lanca (mm)	Nosivost (t)	L (mm)	B (mm)	E (mm)	F (mm)	Težina (kg/ kom)
Chain dia.	WLL					Weight
7/8-10	2,6	65	10	17	10	0,3
10-10	4,0	85	12	20	12	0,7
13-10	6,8	104	16	26	16	1,6
16-10	10,3	131	20	32	19	2,8
20-10	16,0	167	26	41	23	6,1
22-10	20,0	187	26	46	32	8,6
26-10	27,0	228	32	55	38	14,0
32-10	40,0	229	40	50	27	20,7

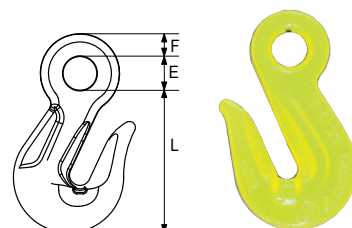

2. PRIBOR G80 I G100 G80 and G100 accessories

2.2. Pribor G100

GUNNEBO

Spojnica lanca G100 G

Coupling link G100

2.1 2.2 3.1 CE BL

Promjer lanca (mm)	Nosivost (t)	L (mm)	B (mm)	F (mm)	A (mm)	C (mm)	Težina (kg/ kom)
Chain dia.	WLL						Weight
6-10	1,5	45	15	7	8	16	0,1
7-10	2,0	56	18	9	11	22	0,2
8-10	2,6	56	18	9	11	22	0,2
10-10	4,0	68	25	12	13	26	0,3
13-10	6,8	89	29	15	17	33	0,7
16-10	10,3	106	36	19	20	40	1,4
20-10	16,0	125	43	23	26	44	2,2
22-10	20,0	152	50	26	28	59	3,6
26-10	27,3	161	58	32	34	61	5,7
32-10	40,0	200	70	38	40	77	9,5

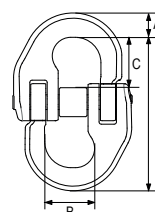

Ovjesna alka G100 MF

Master link G100

2.1 2.2 3.1 CE BL

Nosivost (t)	L (mm)	E (mm)	D (mm)	Težina (kg/ kom)
WLL				Weight
1,5	100	60	11	0,2
2,5	125	70	14	0,4
4,0	140	80	17	0,8
7,5	160	95	22	1,5
10,0	190	110	28	2,8
17,0	240	140	34	5,2
25,0	250	150	40	7,3

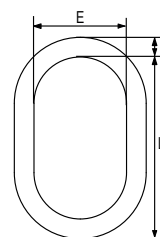

Ovjesna alka u garnituri G100 MT

Master link assembly G100

2.1 2.2 3.1 CE BL

Nosivost (t)	L1 (mm)	L (mm)	E (mm)	D (mm)	l (mm)	e (mm)	d (mm)	Težina (kg/ kom)
WLL								Weight
3,5	270	150	90	19	120	70	14	1,8
5,2	300	160	95	22	140	80	17	3,0
6,9	340	190	110	28	150	90	19	4,9
11,5	360	200	120	30	160	95	22	6,4
17,0	440	250	150	40	190	110	28	14,2
28,0	500	300	200	50	200	120	32	23
35,0	550	300	200	55	250	150	40	31,5
53,0	610	350	200	60	260	140	45	46
70,0	730	450	250	70	280	160	50	71
90,0	730	450	260	80	280	160	55	91

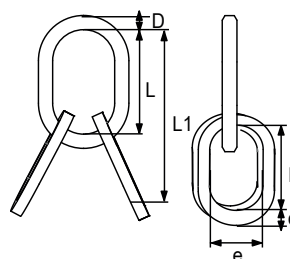

2. PRIBOR G80 I G100 G80 and G100 accessories

2.2. Pribor G100

GUNNEBO

Ovjesna alka G100 MG

Master link MG G100

2.1 2.2 3.1 CE BL

Promjer lanca (mm)	Nosivost (t)	L (mm)	A (mm)	E (mm)	D (mm)	Težina (kg/ kom)
Chain dia.	WLL					Weight
6-10	1,5	145	88	60	15	0,5
8-10	2,6	171	92	60	18	0,9
10-10	4,0	211	113	75	22	1,8
13-10	6,8	261	138	90	26	3,5
16-10	10,3	311	157	105	31	6,1

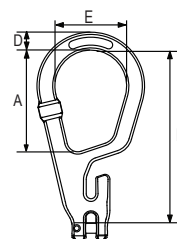

Ovjesna alka G100 MGD

Master link MGD G100

2.1 2.2 3.1 CE BL

Promjer lanca (mm)	Nosivost (t)	L (mm)	A (mm)	E (mm)	D (mm)	Težina (kg/ kom)
Chain dia.	WLL					Weight
6-10	1,5	144	90	60	7	0,7
8-10	2,6	171	100	75	21	1,3
10-10	4,0	211	124	90	24	2,3
13-10	6,8	262	149	105	31	5,2
16-10	10,3	310	175	120	35	7,9

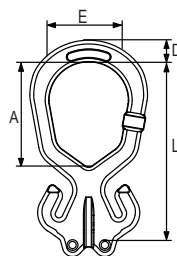

Zatezač lanca-račna G100 GT

Chain tensioner G100

2.1 2.2 3.1 CE BL

Promjer lanca (mm)	Kapacitet povlačenja -LC (daN+)	Realna sila zatezanja	L min (mm)	L max (mm)	Težina (kg/ kom)
Chain dia.	Lashing capacity	STF			Weight
8-10	50	2800	400	600	3,3
10-10	80	2800	400	600	-

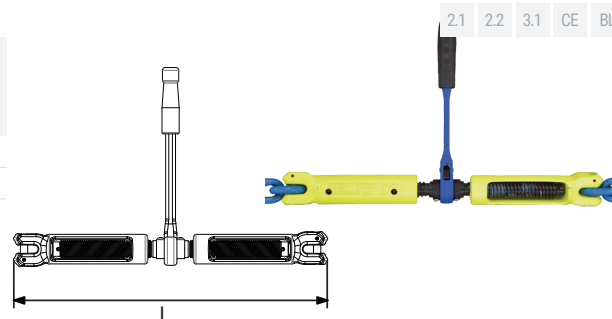

Skračivač G100 MIG

Chain shortener MIG G100

2.1 2.2 3.1 CE BL

Promjer lanca (mm)	Nosivost (t)	L (mm)	X (mm)	Y (mm)	Težina (kg/ kom)
Chain dia.	WLL				Weight
MIG-8-10	2,6	95	50	60	0,627
MIG-10-10	4,0	125	70	77	1,063
MIG-13-10	6,8	150	90	80	2,442
MIG CC-8-10	2,6	95	50	60	0,99
MIG CC-10-10	4,0	125	70	77	0,99
MIG CC-13-10	6,8	150	90	80	2,6

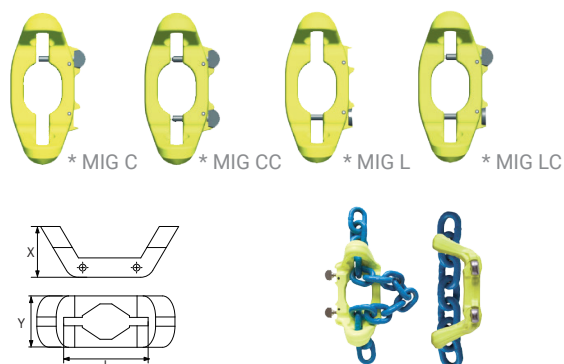

2. PRIBOR G80 I G100 G80 and G100 accessories

2.2. Pribor G100

GUNNEBO

Okretni vijak sa ležajem G100 DLP

De-centered lifting point G100

2.1 2.2 3.1 CE BL

Veličina (mm)	L (mm)	L2 (mm)	B (mm)	C (mm)	D (mm)	E (mm)	F (mm)	G (mm)	L1 (mm)	M (mm)	X (mm)	Y (mm)	Z (mm)	Težina (kg/kom)
Size	Weight													
M8x1,25	13	97,5	35	48	10	39	14	10	78	8	30	55	26	0,3
M10x1,5	13	97,5	35	48	10	39	14	10	78	10	30	55	26	0,3
M12x1,75	23	118	35	48	12	51	20	14	91	12	44	59	32	0,5
M16x2	23	158	35	48	12	51	20	14	91	16	44	59	32	0,5
M20x2,5	34	198	54	88	18	71	28	18	145	20	58	90	48	1,6
M24x3	34	238	54	88	18	71	28	18	145	24	58	90	48	1,7
M30x3,5	53	295	82	94	26	104	39	27	182	30	88	122	75	5,0
M36x4	53	295	82	94	26	104	39	27	182	36	88	122	75	5,2
M42x4,5	73	293	100	104	36	136	54	34	216	42	113	156	110	11,6
M48x5	73	293	100	103	36	136	54	34	216	48	113	156	110	11,9

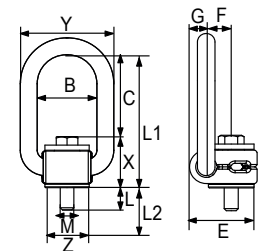
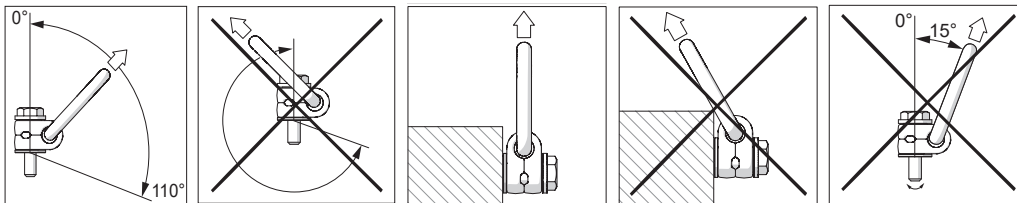

Okretni vijak G100 RLP

Rotating lifting point 100 RLP

2.1 2.2 3.1 CE BL

Veličina (mm)	L (mm)	L2 (mm)	B (mm)	C (mm)	L1 (mm)	M (mm)	X (mm)	Y (mm)	Z (mm)	Težina (kg/kom)
Size	Weight									
M8x1,25	16	101	42	35	62	8	27	64	40	0,3
M10x1,5	16	101	42	35	62	10	27	64	40	0,3
M12x1,75	25	120	57	46	88	12	42	91	54	1,0
M16x2	25	160	57	46	88	16	42	91	54	1,0
M20x2,5	36	200	83	55	110	20	55	133	80	2,9
M24x3	36	240	83	55	110	24	55	133	80	2,9
M30x3,5	58	300	114	70	148	30	78	182	111	7,1
M36x4	58	300	114	70	148	36	78	182	111	7,3
M42x4,5	81	301	149	91	190	42	99	229	142	14,3
M48x5	81	301	149	91	190	48	99	229	142	14,5

